



9155-GPX

TRI-MODE CDMA DIGITAL 1x WIRELESS HANDSET

555 Wireless Boulevard • Hauppauge, New York 11788
800.229.1235 • www.audiovox.com • LTCL0M227 • Rev. 1.4

©2002 Audiovox Communications Corp. • Printed in Japan • 07/02



OWNER'S MANUAL



AUDIOVOX

9155-GPX

Tri-Mode CDMA/AMPS Handheld Portable Cellular Telephone

In today's fast paced world, it has become a necessity to have access to your family and friends as well as real-time information. Your communications tools must provide you with this access from anywhere at anytime. With that in mind, Audiovox developed the 9155-GPX, our first GPS capable 1xtri-mode phone with web browsing and voice activated dialing features.

This 1x digital handset enables carriers supporting 1x technology to provide consumers with access to high speed connectivity for web browsing, email and mobile e-commerce. Operating on the 800 MHz Amps/ CDMA and 1900 MHz PCS frequencies, the 9155-GPX allows for seamless nationwide coverage as well as offering other state-of-the-art user-friendly features. Voice activated dialing and two-way speakerphone are great for enhancing hands-free use of this phone. T9[®] Text Input, vibrating alert and a 7-line LCD Display with adjustable text size make 9155-GPX easier to use. The 9155-GPX also has user changeable faceplates, enabling you to express your individuality through your wireless handset.

Several optional accessories are available for the 9155-GPX, including: hands-free devices, charging devices (vehicle, travel, desktop, AC), data interface cable, belt clip, and of course, color user changeable faceplates.

Your new 9155-GPX provides you with something only an Audiovox phone can: the proven reliability that has made us a leading wireless handset provider. Please take a few moments to read the following pages of the owner's operating manual. It will help you make the most efficient use of this valuable communications tool.

TABLE OF CONTENTS

SAFETY INSTRUCTIONS	7
SAFETY INFORMATION FOR WIRELESS HANDHELD PHONES	14
SAR INFORMATION	17
SYSTEM CONFIGURATION	18
BATTERY FUNCTIONS	19
Attaching Battery Pack	19
Removing Battery Pack	19
Recharging the Battery	20
FUNCTIONS	22
External View	22
Key Functions	23
LCD Display Indication	23
GETTING STARTED	24
Turning the Phone On/Off	24
Antenna Position	24
Receiving Signal Strength Indicator (RSSI)	24
Battery Level Indicator	24
Power Management	24
BASIC OPERATION	25
Placing Calls	25
Placing a Call	25
Terminating a Call	25
Last Number Redial	25
Dialing the Last Incoming Call	25
Phonebook Dialing	25
Speed Dialing	26
Quick Dialing	26
Emergency Call	26
One-Touch Emergency Call	27
Emergency Call Mode	27
Receiving Calls	27
Receiving a Call	27
Any Key Answering	27
Caller ID with Name	28
Automatic Calls-in-Absence Indicator	28
Ringing Tone with Melody	28
Distinctive Ringing (Audible Caller ID)	28
During Calls	28
Adjusting the Earpiece Volume	28
Muting a Phone Conversation	29
Speakerphone Mode (Two-Way)	29
Automatic Talk Timer	29
Scratch Pad Dialing	29
Call Waiting	29
Three-Way Calling	30
Standby	30
Indicators on Standby	30
Vibrating Alert	30
Multilingual	30
End to End Signaling	31
Touch Tone™ from Display	31
Touch Tone™ from Memory	31

Entering Letters and Symbols	32
T9 Mode T9 (T9)	32
Alpha Mode abc (abc)	32
Numeric Mode Num (Num)	33
Symbol Mode Sym (Sym1 to 4)	33
PHONEBOOK OPERATION	34
Phonebook Entry	34
Basic Sequence	34
Storing a Number without Name	35
Automatic Storing into Phonebook	35
Auto Hyphenation	36
Manual Hyphenation	36
Storing Dual Numbers	37
Storing a Name with a Phone Number	38
Storing E-mail Addresses	39
Marking Numbers with Icons	39
Storing a Ringer Type with the Phone Number	40
Overwrite Warning	41
Recall Menu	42
Recall Menu Tree	42
Phonebook Recall	43
Phonebook Address Mode	43
Phonebook Sort Scroll Mode	43
Phonebook Key Word Search Mode	44
Dialing Dual Numbers	45
Reviewing Long Names and Numbers	45
Locating E-mail Addresses	45
Prepending Dialing	45
Phonebook Edit	46
Modifying Numbers and Names	46
Moving Numbers and Names	47
Changing Priority of Dual Numbers	48
Erasing Numbers and Names	48
Secret Memory	49
Storing a Secret Number	49
Recalling a Secret Number	50
Link Dialing	50
Storing Linked Numbers	50
Placing Calls Using Linked Numbers	51
Voice Activated Dialing (VAD)	52
Voice Registration	52
Replaying Registered Voices	53
Voice Activated Dialing	53
Adding Voice to Stored Numbers	53
Deleting Registered Voices	53
Call History	54
Reviewing Outgoing Call History	55
Reviewing Incoming Call History	55
Reviewing Scratch Pad	56
Saving a Number to Phonebook	56
MESSAGING FEATURES	57
Receiving Text Messages	58
Checking Received Messages	58
Sending Text Messages	59
Sending Text Messages	59
Reviewing Sent Messages	60
Voice Mail	61
Voice Mail Notification	61
Voice Mail Dialing 	62

Messaging Feature Settings	63
Default Call Back #	63
Default Delivery Ack	63
New Message Alert	63
Voice Mail Alert	63
Text Entry Mode	64
Save Sent Message	64
Erase All Text Messages	64
SMS Text Lines Selection	64
SMS Memory Management	64
Reply with Copy	64
WEB BROWSING	65
Accessing Internet.....	65
Starting a Web Browser	65
Browser Menu	66
E-mailing with Browser	66
Receiving E-mails	66
Checking Alert Inbox	67
Sending E-mails	67
Web Browser Settings	67
Web Lock	67
Web Backlight	67
Web Idle Timer	67
Confirm — Connect Prompt.....	67
Connection Settings	68
FUNCTION MENU.....	69
Accessing Function Menu	69
Function Menu Tree	70
Lock Features	71
Security Code and Unlock Code	71
Keypad Lock (F11)	71
Phone Lock (F12)	72
Automatic Phone Lock (F13)	72
Unlocking the Phone	72
Changing the Unlock Code (F14)	72
Display Features	73
Own Telephone Number Display (F21)	73
Backlight Control (Standby) (F22-1)	73
Backlight Control (In-Use) (F22-2)	73
Auto Hyphenation (F23)	74
Language Selection (F24)	74
Contrast Control (F25)	74
Software Version Display (F26)	74
Last Rescan SID Indicator (F27)	74
PRL ID Review (F28)	74
Volume and Tone Controls	75
Ringer Volume Control (F31)	75
Ringer Type Selection (F32).....	75
Key Tone Volume Control (F33)	75
Sending DTMF (F34)	75
Key Tone Length (F35-1)	76
Single Alert Beep Tone (F35-2).....	76
Caller ID Alert (F35-3).....	76
Service Mode Alert (F35-4)	76
Voice Privacy Alert (F35-5)	77
One Minute Beep Tone (F35-6).....	77
Low Battery Alarm (F35-7).....	77

Call Timers	77
Last Call Timer (F41-1)	77
Outgoing Call Timer (F41-2)	77
All Calls Timer (F41-3)	78
Lifetime Timer (F41-4)	78
Web Total Timer (F41-5)	78
Clock Indicator (F42)	78
Clock Adjustment (F43)	79
Clock Alarm (F44)	79
Countdown Timer (F45)	80
System Features	81
A/B System Selection (F51)	81
Enhanced Roaming	81
NAM Selection (F52)	82
Force Analog Call (F53)	82
NAM Name Display (F54-1)	83
Automatic NAM (F54-2)	83
Automatic Retry (F54-3)	83
Enhanced Voice Privacy Service (F54-4)	83
Security Features	84
Call Restriction (F61)	84
Changing Emergency Numbers (F62)	85
Turning On/Off One-Touch Emergency Call Feature (F63) ..	85
Changing Security Code (F64)	85
Call Timer Reset (F65-1)	85
Phonebook All Clear (F65-2)	86
Call History All Clear (F65-3)	86
Text Message & Voice Mail All Clear (F65-4)	86
Function Reset (F65-5)	86
Data Communications	87
Service Mode (F71)	87
Data/Fax Mode (F72)	88
TTY Mode (F73)	88
Vibrator	89
Vibrating Alert (F8)	89
Voice Dialing	90
Voice Activated Dialing (F9)	90
Other Functions	90
Quick Dialing (F01)	90
Automatic Answering (F02)	90
Redial Soft Key (F04)	90
Location (F05)	90
Function Reset Status	91
FACEPLATE OPTIONS	93
FDA CONSUMER UPDATE	94
EMERGENCY CALLS	98
OPERATING PROCEDURES	99
INDEX	100
12 MONTH LIMITED WARRANTY	101
QUICK REFERENCE	103
ACCESSORIES	105

Touch Tone™ is a registered trademark of AT & T.



SAFETY INSTRUCTIONS

WARNING : Always read and understand all of the **Warnings and Safety Instructions** contained in this Manual before attempting to use this Audiovox 9155-GPX Cellular Phone, to help avoid potential hazards that could result in bodily injury or property damage.

Always keep this Manual conveniently available for future reference, as it contains important information that will help effect the safe operation and maintenance of this instrument.

The safety instructions have been classified according to the seriousness of the risk, as follows :

DANGER : “**Danger**” indicates the existence of a hazard that could result in death or catastrophic bodily injury, if the safety instruction is not observed.

WARNING : “**Warning**” indicates the existence of a hazard that could result in serious bodily injury, if the safety instruction is not observed.

CAUTION : “**Caution**” indicates the existence of a hazard that could result in minor bodily injury or property damage, if the safety instruction is not observed.

NOTICE : “**Notice**” contains general information that relates to the safe operation of the telephone.



Safe Operation of Your Phone

WARNING

- Never attempt to disassemble the phone or any of its accessories. If service or repair is required, return the unit to an Audiovox authorized service center. If the unit should be disassembled, a risk of electric shock or fire may result.
- Always use authorized Audiovox accessories and optional devices when operating this cellular phone, as the use of incompatible auxiliary equipment could result in fire, electric shock or other bodily injury. The use of unauthorized accessories will also void your Warranty.

Protection of Children

- Never allow children to play with your phone, as they might hurt themselves or others (e.g., by poking themselves or others in the eye with the antenna).
- Always keep all accessories and components out of the reach of small children. Small parts, in particular, might present a choking hazard to children.

Use in Vehicles

- Never store or transport flammable liquids, gases or explosive materials in the same compartment as the phone or any of its accessories, as possible sparking in the equipment could ignite a fire or explosion.
- Always secure the phone in its holder, when it is not in use. Never place the phone on the passenger seat or anyplace else in the car where it can become a projectile during a collision or sudden stop.

CAUTION

- Never expose this phone to high temperatures, such as those found near a heater or in a closed car parked in the sun. This can cause heat-damage to the plastic parts, the electronic components and the battery.
- Never drop this phone or subject it to violent impact or shock. This can cause mechanical damage.
- Never allow any liquids to spill on this phone or expose it to rain, water or moisture. This can cause corrosion damage.
- Never store this phone in cold areas. When the phone warms up (to its normal operating temperature), moisture can form inside the phone, which may damage the phone's electronic circuit board.
- Never use harsh chemicals, cleaning solvents, or strong detergents to clean this phone. Always clean it with a soft cloth that has been slightly dampened in a mild soap-and-water solution.
- Never paint this phone. This can clog the moving parts.

Before connecting this cellular phone or any of its accessories to any other device, always read the Instruction Manual for that other device first to obtain detailed safety instructions. Never connect this cellular phone to any unauthorized or incompatible auxiliary product that has not been expressly approved by Audiovox.



Safe Operation of Battery Pack

WARNING

- Never short-circuit a battery pack by either accidentally or intentionally bringing the terminals in contact with another metal object. That could result in burns, other bodily injury or a fire, and could also damage the battery pack.
- Never expose the terminals of the battery pack to any other metal object. Always wrap it or place it in a plastic bag, whenever transporting it.
- Never heat and never attempt to disassemble the battery pack, as that could cause leakage of the caustic electrolyte. If the battery is accidentally broken, avoid skin contact with the contents. In the event of skin contact, wash the affected area immediately and obtain prompt medical attention.
- Never attempt to dispose of a battery pack by throwing it into a fire. That can cause the battery pack to explode.
- Never attempt to use an unauthorized battery pack with your phone in order to avoid any risk of bodily injury or property damage. Since unauthorized accessories have different specifications, they may be incompatible with your phone.

WARNING

Safe Disposal of Used Battery Packs

- Never discard a used battery pack with ordinary solid wastes, since it contains toxic substances.
- Always dispose of a used battery pack in accordance with prevailing community regulations relating to the disposal of household toxic wastes. Always cover the metal terminals with insulating tape first, to prevent accidental short-circuiting.



CAUTION

- Always turn your phone OFF before removing the battery pack, and always use the battery pack for its intended purpose only.
- Always use the battery pack supplied by Audiovox, or an approved replacement battery pack, to avoid any risk of damage to your cellular phone.



Safe Operation of AC Adapter

The AC Adapter and the Desktop Charger that were designed by Audiovox for this unit both require the use of a standard 120 V AC power source for their operation.

DANGER

- Never attempt to disassemble or repair an AC adapter or desktop charger, as exposure to electric shock hazards may result. Always contact an Audiovox authorized service center, if repair or replacement is required.
- Never alter the AC cord or plug on your AC adapter or desktop charger. If the plug will not fit into the available outlet, have a proper outlet installed by a qualified electrician. Improper connection can result in the risk of electric shock.

WARNING

- Never allow any liquids or water to spill on the AC adapter or desktop charger when it is connected to an AC power source. There is a risk of fire or electric shock.
- Always use the authorized Audiovox AC adapter or desktop charger to avoid any risk of fire or damage to your cellular phone or battery. Bodily injury or property damage may occur as a result of the use of an unauthorized and incompatible AC adapter or desktop charger.
- Never use an AC adapter or desktop charger if it has a damaged or worn power cord or plug. The use of damaged or worn power cords or plugs could result in electric shock, burns or fire. Contact an Audiovox authorized service center immediately to obtain a suitable replacement.

WARNING

- Always unplug the AC adapter or desktop charger from the power source before attempting any cleaning in order to avoid the risk of electric shock. Always use a soft cloth dampened with water to clean the equipment, after it has been unplugged.
- Never attempt to use an unauthorized AC adapter or desktop charger with your phone in order to avoid any risk of bodily injury or property damage. Since unauthorized accessories have different specifications, they may be incompatible with your phone.

CAUTION

- Always confirm that the power cord for any accessory is located so that it will not be stepped on, tripped over, or otherwise subjected to damage or stress.
- Never place heavy objects on a power cord, as this could result in damage to the cord.
- Never bend or twist a power cord, and never pull on a power cord in an attempt to remove an AC adapter or accessory plug from a socket. Always grasp the AC adapter or the accessory plug directly when unplugging the device in order to avoid damaging the cord.
- Always disconnect the AC adapter or desktop charger from the power source when it is not in use.

SAFETY INFORMATION FOR WIRELESS HANDHELD PHONES

Read this information before using your handheld portable Cellular Telephone.

Your wireless handheld portable telephone is a low power radio transmitter and receiver. When it is ON, it receives and also sends out radio frequency (RF) signals.

FCC RF EXPOSURE INFORMATION

In August 1996, the Federal Communications Commission (FCC) of the United States, with its action in Report and Order FCC 96-326, adopted an updated safety standard for human exposure to radio frequency (RF) electromagnetic energy emitted by FCC regulated transmitters. Those guidelines are consistent with the safety standard previously set by both U.S. and international standards bodies. The design of this phone complies with the FCC guidelines and these international standards.

Use only the supplied or an approved antenna. Unauthorized antennas, damaged antennas, modifications, or attachments could impair call quality, damage the phone, or result in violation of FCC regulations. Please contact your local dealer for replacement antenna.

Body-worn Operation

This device was tested for typical body-worn operations with the BC-9100 belt-clip and LB-9100 holster models, offered by Audiovox as an accessory to this phone, and found to comply with FCC RF exposure requirements. Third-party belt-clips, holsters and similar accessories should be avoided, as they have not been tested and may not comply with FCC RF exposure limits.

For more information about RF exposure, please visit the FCC website at www.fcc.gov.

PHONE OPERATION

Normal position: Hold the phone as you would any other telephone with the antenna pointed up and over your shoulder.

Tips on Efficient Operation:

For your phone to operate most efficiently:

- Extend your antenna fully.
- Do not touch the antenna unnecessarily when the phone is in use. Contact with the antenna affects call quality and may cause the phone to operate at a higher power level than otherwise needed.

DRIVING

Check the laws and regulations on the use of wireless telephones in the areas where you drive. Always obey them. Also, if using your phone while driving, please:

- Give full attention to driving — driving safely is your first responsibility.
- Use hands-free operation, if available.
- Pull off the road and park before making or answering a call if driving conditions so require.

ELECTRONIC DEVICES

Most modern electronic equipment is shielded from RF signals. However, certain electronic equipment may not be shielded against the RF signals from your wireless phone.

Pacemakers

The Health Industry Manufacturers Association recommends that a minimum separation of six (6") inches be maintained between a handheld wireless phone and a pacemaker to avoid potential interference with the pacemaker. These recommendations are consistent with the independent research by and recommendations of Wireless Technology Research.

Persons with pacemakers:

- Should ALWAYS keep the phone more than six (6") inches from their pacemaker when the phone is turned ON.
- Should not carry the phone in a breast pocket.
- Should use the ear opposite the pacemaker to minimize the potential for interference.
- If you have any reason to suspect that interference is taking place, turn your phone OFF immediately.

Hearing Aids

Some digital wireless phones may interfere with some hearing aids. In the event of such interference, you may want to consult your service provider [or call the customer service line to discuss alternatives].

Other Medical Devices

If you use any other personal medical device, consult the manufacturer of your device to determine if they are adequately shielded from external RF energy. Your physician may be able to assist you in obtaining this information.

Turn your phone OFF in health care facilities when any regulations posted in these areas instruct you to do so. Hospitals or health care facilities may be using equipment that could be sensitive to external RF energy.

Vehicles

RF signals may affect improperly installed or inadequately shielded electronic systems in motor vehicles. Check with the manufacturer or its representative regarding your vehicle. You should also consult the manufacturer of any equipment that has been added to your vehicle.

Posted Facilities

Turn your phone OFF in any facility where posted notices so require.

AIRCRAFT

FCC regulations prohibit using your phone while in the air. Switch OFF your phone before boarding an aircraft.

BLASTING AREAS

To avoid interfering with blasting operations, turn your phone OFF when in a "Blasting area" or in areas posted "Turn off two-way radio". Obey all signs and instructions.

POTENTIALLY EXPLOSIVE ATMOSPHERES

Turn your phone OFF when in any area with a potentially explosive atmosphere and obey all signs and instructions. Sparks in such areas could cause an explosion or fire resulting in bodily injury or even death.

Areas with a potentially explosive atmosphere are often, but not always marked clearly. Potential areas may include: fueling areas (such as gasoline stations); below deck on boats; fuel or chemical transfer or storage facilities; vehicles using liquefied petroleum gas (such as propane or butane); areas where the air contains chemicals or particles (such as grain, dust, or metal powders); and any other area where you would normally be advised to turn off your vehicle engine.

For Vehicles Equipped with an Air Bag

An air bag inflates with great force. DO NOT place objects, including either installed or portable wireless equipment, in the area over the air bag or in the air bag deployment area. If in-vehicle wireless equipment is improperly installed and the air bag inflates, serious injury could result.

SAR INFORMATION

THIS MODEL PHONE MEETS THE GOVERNMENT'S REQUIREMENTS FOR EXPOSURE TO RADIO WAVES.

Your wireless phone is a radio transmitter and receiver. It is designed and manufactured not to exceed the emission limits for exposure to radiofrequency (RF) energy set by the Federal Communications Commission of the U.S. Government. These limits are part of comprehensive guidelines and establish permitted levels of RF energy for the general population. The guidelines are based on standards that were developed by independent scientific organizations through periodic and thorough evaluation of scientific studies. The standards include a substantial safety margin designed to assure the safety of all persons, regardless of age and health.

The exposure standard for wireless mobile phones employs a unit of measurement known as the Specific Absorption Rate, or SAR. The SAR limit set by the FCC is 1.6 W/kg.* Tests for SAR are conducted with the phone transmitting at its highest certified power level in all tested frequency bands. Although the SAR is determined at the highest certified power level, the actual SAR level of the phone while operating can be well below the maximum value. This is because the phone is designed to operate at multiple power levels so as to use only the power required to reach the network. In general, the closer you are to a wireless base station antenna, the lower the power output.

Before a phone model is available for sale to the public, it must be tested and certified to the FCC that it does not exceed the limit established by the government-adopted requirement for safe exposure. The tests are performed in positions and locations (e.g., at the ear and worn on the body) as required by the FCC for each model. The highest SAR value for this model phone when tested for use at the ear is 1.45 W/kg and when worn on the body, as described in this user guide, is 0.72 W/kg. (Body-worn measurements differ among phone models, depending upon available accessories and FCC requirements). While there may be differences between the SAR levels of various phones and at various positions, they all meet the government requirement for safe exposure.

The FCC has granted an Equipment Authorization for this model phone with all reported SAR levels evaluated as in compliance with the FCC RF exposure guidelines. SAR information on this model phone is on file with the FCC and can be found under the Display Grant section of <http://www.fcc.gov/oet/fccid> after searching on FCC ID CJ6DCE45380A.

Additional information on Specific Absorption Rates (SAR) can be found on the Cellular Telecommunications & Internet Association (CTIA) web-site at <http://phonefacts.net>.

* In the United States and Canada, the SAR limit for mobile phones used by the public is 1.6 watts/kg (W/kg) averaged over one gram of tissue. The standard incorporates a substantial margin of safety to give additional protection for the public and to account for any variations in measurements.

SYSTEM CONFIGURATION

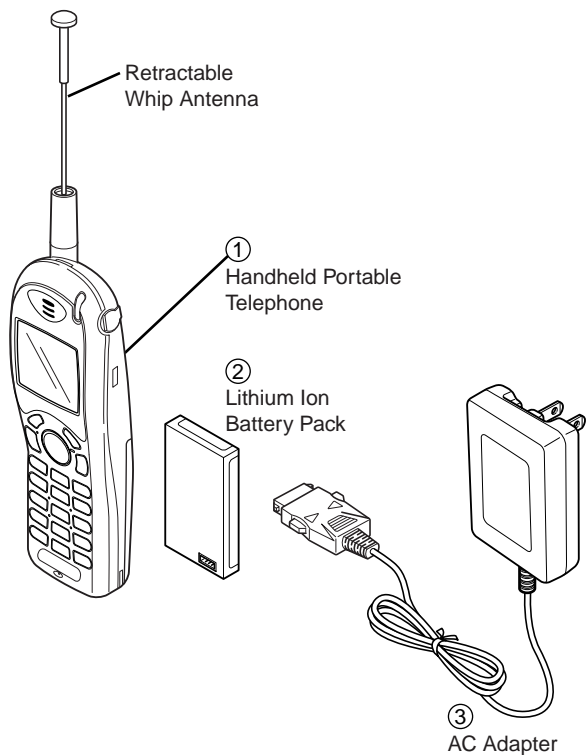

List of Equipment

No.	Name of the Equipment
①	Handheld Portable Telephone
②	Lithium Ion Battery Pack (BTR-9100)
③	AC Adapter (CNR-9100)

BATTERY FUNCTIONS

Attaching Battery Pack

1. Press and slide the battery cover to remove it.

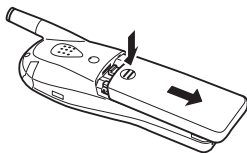

2. Place the BTR-9100 battery pack in the battery cavity so that it fits over the connector.

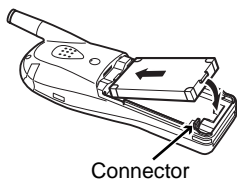

3. Slide the cover back to snap it on.

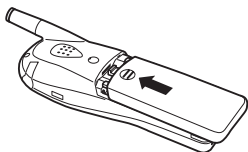

Removing Battery Pack

1. Press and hold  key to turn the phone off. Then press and slide the battery cover to remove it.

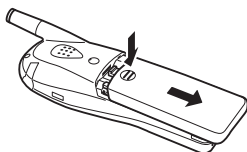

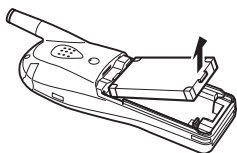

2. Lift the battery pack up to take it out.



Recharging the Battery

Your 9155-GPX phone has a built-in charger function.

To recharge the Battery Pack:

1. Insert the BTR-9100 Battery Pack into the phone's battery cavity.
2. If the phone is on with the  indicator displayed, press and hold  to turn the phone off.
3. Insert the flat connector end of the CNR-9100 AC Adapter into the connector port on the bottom of the phone.
4. Plug the AC Adapter into AC120V outlet.
5. **"Now Charging"** will display with animation and the  indicator will scroll in the upper right corner of the screen. The Charging Indicator at the top of the phone will light green.
6. **"Fully Charged!"** displays when charging is complete.
7. Disconnect the AC Adapter from the outlet.
8. Press and hold in the buttons on the flat connector of the AC Adapter and pull the connector away from the phone.

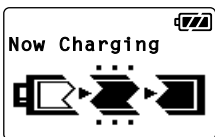

The recharging time, from empty to full, depends on the environmental temperature, 0 to +35 °C.

Battery Type	Recharging Time
Lithium Ion Battery Pack (BTR-9100)	1.5 to 2 h

- Notes:**
1. For complete recharging, it is recommended that the phone be turned off during recharging.
 2. It is normal for the battery to become a little warmer during recharging.
 3. Do not feed power to the phone without the battery pack attached.

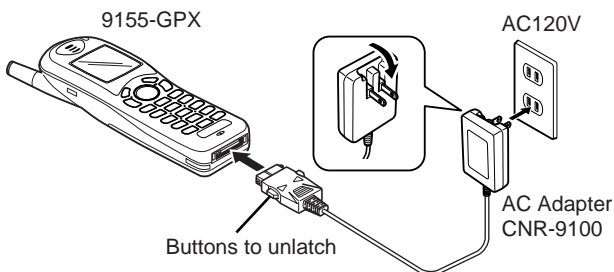

Recharging with the Desktop Holder

The CNR-9100 AC Adapter and the optional accessory DTH-9100 Desktop Holder can also be used to recharge the phone as illustrated below.

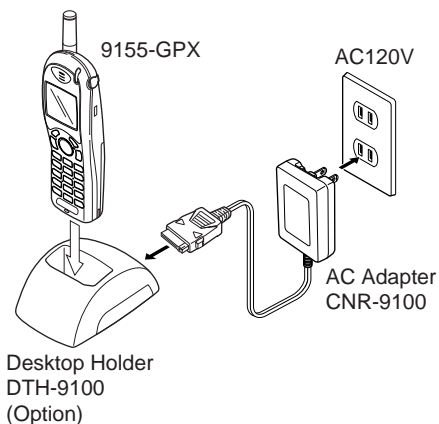

Battery Information







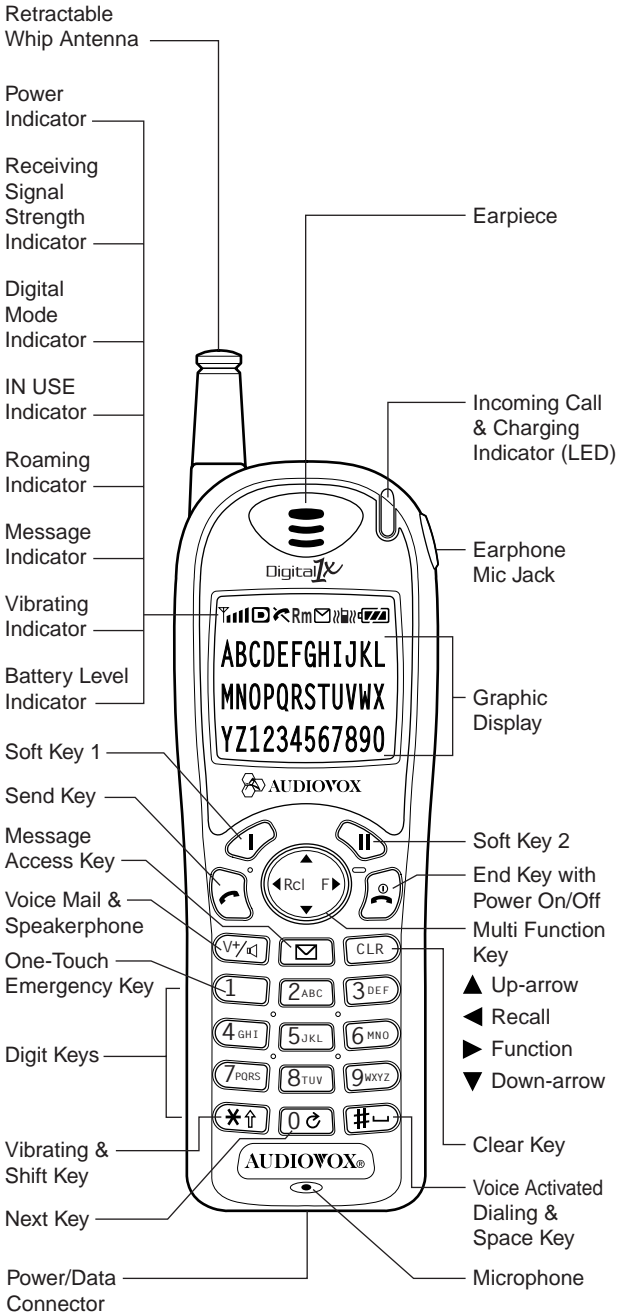



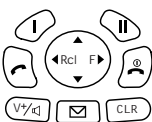

- Temperature extremes affect the Battery Pack's ability to charge; always allow it to completely cool down or warm up first.
- Subjecting the Battery Pack to extremely high or low temperatures will reduce its capacity and its life expectancy. Always try to keep the Battery Pack between 59°F and 77°F (15°C and 25°C), if possible.

FUNCTIONS









External View



Key Functions



Key-Board Arrangement	Digit Keys  Use to enter Telephone Numbers and letters and symbols (see page 32).  used for One-Touch Emergency Feature.	
	Function Keys 	
		Soft Keys. Functions as shown in the bottom line on the display.
		SEND Key. Originates or answers a call.
		END Key. Terminates a call and turns the phone ON/OFF.
		Recalls phone numbers from memory and serves as left-arrow key.
		Used with other keys to activate special features. And serves as right-arrow key.
		Controls the volume of Ringer, Key Tone and Earpiece/Speakerphone and used for up/down-arrow keys.
		Accesses Voice Mail (see page 62) and activates Speakerphone mode (see page 29).
		Displays number of messages and reviews Text Messages (see page 57).
	Clears digits from the display or from a memory location.	

LCD Display Indication

Items	Descriptions
	Receiving Signal Strength Indicator. Indicates Signal Strength, and  is also a POWER ON indicator.
	Digital Mode Indicator. Phone is operating in digital mode.
	Call in progress.
	Out of Service Area.
Rm	Out of the Home Area.
	Message Indicator. Indicates new Text or Voice Mail messages.
	Vibrating Indicator. Vibrating alert is active.
	Battery Level Indicator. Monitors the battery charge condition.
ABCDEFGHIJKL MNOPQRSTUVWXYZ 1234567890	Graphic full-dot matrix display with flexible font size in 3 to 7 lines.

GETTING STARTED

Turning the Phone On/Off

Press and hold . Indicators and display will momentarily light, and a tone will be heard. To turn the phone off, press and hold .

Antenna Position



The antenna can only be used in its fully extended or fully retracted position. For optimum performance and signal strength, or while operating in poor signal areas, fully extend it.

Receiving Signal Strength Indicator (📶)

This icon indicates the strength of the signal your phone is receiving. Four lines indicate maximum signal strength. Line total may change as you move with the phone to represent the changing signal strength. If the signal is not strong enough to place a call, “📶” will appear on the display.

Battery Level Indicator

Monitor the battery charge condition with the level indicator. The number of blocks indicates the battery conditions as follows:

-  Full charge
-  Low charge
-  Flashing indicates discharged.

Power Management

Battery	Mode	Talk Time up to	Standby Time up to
Lithium Ion (BTR-9100)	Digital 1x	125 min.	270 h
	Digital	170 min.	150 h
	Analog	60 min.	15 h

The operating times are approximate values and may vary depending on network configuration and handset usage.



BASIC OPERATION

Placing Calls

Placing a Call

1. Enter the phone number.
(A maximum of 32 digits will be displayed.)



2. Press .
- The  indicator will appear on the display.

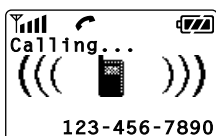



- **To Correct a Number**



Press  to clear the last digit.

Press and hold  to erase all the digits entered.



- **If the Call Fails to Go Through**

Press  and  to redial the number.

Terminating a Call

Press . The  indicator will no longer appear in the display.



Last Number Redial

1. Press the key under **Redial**, or press   to recall the last number dialed.

2. Press  to place the call.



See **Call History** on page 54 for details. See also **Redial Soft Key (F04)** on page 90.

Dialing the Last Incoming Call

To recall the last incoming Caller ID call, press  , then press .

See **Call History** on page 54 for details.

Phonebook Dialing

Press  and enter an address (01 to 99) to recall a number from your phonebook, then press .



See **Phonebook Recall** on page 43 for details.

Tip: The  key will be used for Voice Mail access. See page 62.

Tip: Press and hold  for Voice Activated Dialing. See page 53.

Speed Dialing



Phone numbers stored in memory can be called without using .

1. Enter the one or two digits of your Phonebook address (1 to 9 or 10 to 99).
2. Press . The phone number will be displayed. The  indicator will be displayed and the call will be placed.

Note: If two telephone numbers are stored in the address, the Primary Number will be dialed.

Quick Dialing

When this feature is on, the Primary number in your Phonebook address 02 to 09 can be dialed with just one push of the key. See **Quick Dialing (F01)** on page 90 to turn this feature on/off.





1. Press a digit key ( to ) for more than one second.
2. The number in your phonebook is automatically dialed. The phone number will be displayed. The  indicator will light.

Note: The key  is not for Quick Dialing, but for **One-Touch Emergency Call**, page 27.

Emergency Call

This feature permits you to place an emergency call even if your telephone is in “**Phone Lock**”, “**Keypad Lock**” or “**Restrict**” mode. Up to 3 numbers can be programmed as Emergency numbers. The emergency numbers “**911**” and “***911**” are already preprogrammed. See **Changing Emergency Numbers (F62)** on page 85.

Example: To Call 911 in “**Phone Lock**” or “**Keypad Lock**” mode.

1. Enter   . The “**911**” will not be displayed.
2. Press .
The “**911**” will be displayed.
The  indicator will light, and the call will be placed.

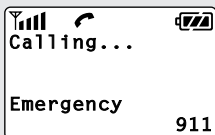



The emergency calls “**911**” and “***911**” are momentarily interrupted, while the phone receives the GPS (Global Positioning System) signals under the digital mode operation.

Important: See **EMERGENCY CALLS** on page 98.

One-Touch Emergency Call

Dials an emergency number with a single key stroke, even in the “**Phone Lock**” or “**Restrict**” mode and can be turned off to prevent unintentional calls to the emergency number.

See **Turning On/Off One-Touch Emergency Call Feature (F63)** on page 85.

1. Press and hold  for more than 2 seconds. The number in emergency memory location “1” will be dialed.
2. Then the  indicator will be displayed and the call will be placed. (The factory preset number is “911”.)

Note: This feature cannot be used if the Keypad Lock is on. You need to dial all the digits and .



Emergency Call Mode

When one of the 3 preprogrammed emergency numbers is dialed the phone enters **Emergency Call Mode** and will attempt to complete the emergency call using any available cellular system it can find. After the call is placed, the phone will stay in the **Emergency Call Mode**, and attempt to continue to receive service from the cellular system used to complete the call. “**Emergency Call Mode, END to exit**” will display and the phone will automatically exit the **Emergency Call Mode** after 5 minutes or after you press .

Receiving Calls



The phone sounds an alert or vibrates to alert you of an incoming call. Also, the LED on the top of the phone will flash.

Receiving a Call

Press  to answer the call. The  indicator will be displayed.

Note: To mute the ringer or stop the vibrating, press .

Any Key Answering

This feature permits you to answer an incoming call by pressing any key on the key pad except  and .

Caller ID with Name

Displays the number and name of the party calling you. The last 10 Caller IDs are stored in the memory for review and redial. See **Call History** on page 54 for details.

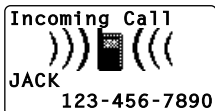

Note: "Number Restricted" or "Number Unavailable" is displayed when Caller ID is restricted or unavailable.

Automatic Calls-in-Absence Indicator

Indicates the number of unanswered incoming calls along with their name and number, by displaying "Called XX", the number of calls (01 to 99) you missed and through a blinking LED. Press the key under **Refer** to view **Incoming Call History**. Depressing any key will clear the display. See **Redial Soft Key (F04)** on page 90.

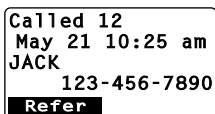

Ringtone with Melody



The 9155-GPX offers 15 different ringer tones and melodies. See **Ringer Type Selection (F32)** on page 75 and **Ringer Volume Control (F31)** on page 75 and **Vibrating Alert (F8)** on page 89 for more information.

Distinctive Ringing (Audible Caller ID)

Different ringer styles can be assigned to different phonebook addresses. See **Storing a Ringer Type with the Phone Number** on page 40 for setting information.





During Calls

Adjusting the Earpiece Volume

Simply press  or  to adjust Earpiece/Speakerphone Volume during a call.







Muting a Phone Conversation

1. Press the key under **Mute**, or press  .
2. Then the screen displays “**Phone is muted!**”.
3. To return to normal mode, press the key under **Unmute**, or press   again.

Note: Terminating a call cancels the muting.

Speakerphone Mode (Two-Way)

1. To activate this feature, press  during a call. The screen displays “**Speaker ON!**”.
2. Press  or  to adjust the earpiece/speakerphone volume.
3. To return to normal mode, press  again.

Notes: 1. Terminating a call cancels the speakerphone mode.
2. It is not recommended to use this feature in a noisy environment.

Automatic Talk Timer

The talk time of the current call will be automatically displayed. For example, “**1H 23M 45S**”.



Scratch Pad Dialing

When you enter a telephone number during a call, the number will be stored in the Scratch Pad memory and can be dialed by pressing  after terminating the call.

Note: You can deactivate “**Sending DTMF**” so that keypad tones will not be transmitted to the calling party. See **Sending DTMF (F34)** on page 75.



Call Waiting

If you have Call Waiting service you may hear a beep tone when you are on a call alerting you of an incoming call. “**New Caller**” is displayed along with the new caller’s name and number.

1. Press  to answer the new call.
2. Press  again to switch between the two calls.

Three-Way Calling

Three-Way Calling allows you to call a third party when a call is already in progress.

1. Enter a number and press  to call the third party.
2. Press  again to connect all three parties.

Ask your service provider for the detailed information.

Standby

Indicators on Standby

In standby, your phone displays date and time, various settings status, and soft keys.

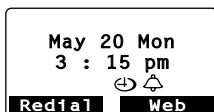

1X : See **Service Mode (F71)** on page 87.

 : **Ringer Volume** is in **Silent** mode. See page 75.

 : **Automatic Answering** is active. See page 90.

 : **Phone Lock** is active. See page 72.

 : **Keypad Lock** is active. See page 71.

 : **Countdown Timer** is active. See page 80.



 : **Clock Alarm** is active. See page 79.

Redial : See **Last Number Redial** on page 25.

Web : See **Accessing Internet** on page 65.

Note: For displaying date and time, see **Clock Indicator (F42)** on page 78 and **Clock Adjustment (F43)** on page 79.

Vibrating Alert

To activate Vibrating Alert, press and hold . The  indicator will be displayed. To deactivate it, press and hold  again. See also **Vibrating Alert (F8)** on page 89.

Multilingual

Menus and prompts can be displayed in English, Spanish, French and Portuguese. See **Language Selection (F24)** on page 74 for more information.

End to End Signaling

Touch Tone™ signaling is required to utilize certain phone services, such as accessing an alternate long distance network, signaling a pager or banking by phone, etc. The following features will make it easy to send frequently used Touch Tone™ signals. See **Link Dialing** on page 50 for more information.

Touch Tone™ from Display

When **Sending DTMF** (page 75) mode is on, the numbers will be sent in Touch Tone™ signals during a call as you press digit keys. When **Sending DTMF** mode is off, you can send Touch Tone™ signals in the following manner.

1. Enter the number.



2. Press  and scroll to "Tone".

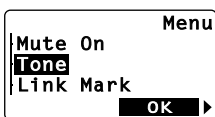



3. Press . The number in the display will be sent in Touch Tone™ signals.

Touch Tone™ from Memory

Touch Tone™ signals can be sent from memory during a call.

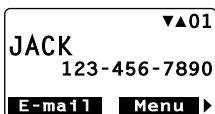
1. Press , and recall the number you want to send in Touch Tone™ signals.



2. Press  and scroll to "Tone".

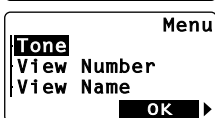

3. Press . The number in the display will be sent in Touch Tone™ signals.

Entering Letters and Symbols

The text entry mode **T9** or **Alpha** will automatically be activated when entering letters, such as names or messages. The current mode — **T9** (T9) or **abc** (abc) — is displayed at the bottom of the screen. The numeric or symbol mode will appear by pressing the key under **T9** (T9) or **abc** (abc).

T9 Mode **T9** (T9)

The T9 mode allows you to enter text quickly by pressing one key per letter. This mode suggests English words as you type.



Example:

1. Type **4** (GHI) **6** (MNO). Your phone displays **in**.
2. Press **0** (↻) to display the next choice **go**.
3. Press **#** (↵) to decide the word “go” and add a space.

The **Shift** key ***↑** turns letter cases: **T9** (normal), **T9↑** (initial cap.) and **T9↑↑** (caps. lock).

The **Next** key **0** (↻) displays the next choice.

The **Space** key **#** (↵) decides a word and adds a space.

Press **F** (→) to select a word.

Press **1** to insert punctuation.

Press **CLR** to delete a character.

Press and hold **CLR** to delete a word.

Press **⬅** (Rcl) or **F** (→) to move the cursor.

Press and hold the key **0** (↻) to **9** (WXYZ) to enter digits.

Note: For more information, visit www.T9.com.

Alpha Mode **abc** (abc)

The Alpha mode allows you to enter characters by pressing the digit key repeatedly. For example, press **5** (JKL) once to enter “J”, or press **5** (JKL) three times to enter “L”.

The **Shift** key ***↑** turns letter cases: **abc** (normal), **Abc↑** (initial cap.) and **ABC↑↑** (caps. lock).

The **Space** key **#** (↵) adds a space.

Press **F** (→) to select a character.

Press **CLR** to delete a character.

Press and hold **CLR** to delete a word.

Press **⬅** (Rcl) or **F** (→) to move the cursor.

Press and hold the key **0** (↻) to **9** (WXYZ) to enter digits.

Assigned Alpha Characters in Alpha Mode

Key	English	Spanish
1	1 @ . ? ! - : ' , ;	
2 ^{ABC}	A B C 2	A Á B C 2
3 ^{DEF}	D E F 3	D E É F 3
4 ^{GHI}	G H I 4	G H I Í 4
5 ^{JKL}	J K L 5	J K L 5
6 ^{MNO}	M N O 6	M N Ñ O Ó 6
7 ^{PQRS}	P Q R S 7	P Q R S 7
8 ^{TUV}	T U V 8	T U Ü Ú V 8
9 ^{WXYZ}	W X Y Z 9	W X Y Z 9
0	0	0

Key	French	Portuguese
1	1 @ / - : ' ? . , () ;	
2 ^{ABC}	A À Â B C Ç 2	A À Á Ã B C Ç 2
3 ^{DEF}	D E Ë È É Ê F 3	D E É Ê F 3
4 ^{GHI}	G H I Ï Î 4	G H I Í 4
5 ^{JKL}	J K L 5	J K L 5
6 ^{MNO}	M N O Ô 6	M N O Ó Ô Õ 6
7 ^{PQRS}	P Q R S 7	P Q R S 7
8 ^{TUV}	T U Ù Û V 8	T U Ü Ú V 8
9 ^{WXYZ}	W X Y Z 9	W X Y Z 9
0	0	0

Note: Available languages in the Alpha mode depend on the feature that you use.

Numeric Mode **Num** (Num)

Press the key **0** to **9** to enter digits; press **CLR** to delete a digit.

Symbol Mode **Sym** (Sym1 to 4)

The symbol mode appears in two ways depending on the feature that you use.

All Symbols on One Screen

Move the cursor with **←Rd F→** to select one of symbols on the screen. Press the key under **OK** to select it and return to the previous mode.

Symbols on Multi-Screen (Web Browser)

Scroll the screens **Sym1**, **Sym2**, **Sym3** and **Sym4** with **▲** or **▼**. Press the digit key (**1** to **9**) to select a symbol and return to the previous mode.

Shortcut: Press and hold the key under **T9** or **abc** to turn to **Sym**. (except Web Browser)

PHONEBOOK OPERATION

The Enhanced Phonebook with 99 dual-number memory addresses stores up to two telephone numbers and an e-mail address per entry. Stored numbers can be easily recalled and dialed by pressing . Mark them Secret for added privacy. A phonebook entry can also be saved with a voice recording for Voice Activated Dialing.

Phonebook Entry

Basic Sequence

To program your phonebook, enter the information in the following order. You may skip “name”, “e-mail address” and/or “voice.”

1. Enter the **phone number(s)**.

See page 35 and 37.



987-654-3210
STO Menu ▶

2. Enter the **name**. See page 38.

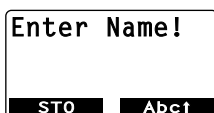

Enter Name!
STO Abct ▶

3. Enter the **e-mail address**.
See page 39.

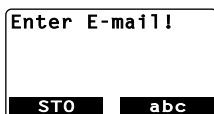

Enter E-mail!
STO abc ▶

4. Enter the **phonebook address**. See page 35.



Address: __
Auto: 01
STO Option ▶

5. Enter the name using your **voice**. See page 52.



Voice Data
Entry
Yes
No
OK ▶

Note: When shifted from **Text Messages**, the sequence may vary depending on cases.

Storing a Number without Name

1. Press or press and hold to clear the screen, then enter the phone number (up to 32 digits).
2. Press the key under **STO** three times, then enter the desired memory address (01 through 99) and press .

Example: To store the phone number 1 2 3 4 5 6 7 8 9 0 in address 07.

1. Press and hold .
2. Enter .
3. Press the key under **STO** three times.
4. Enter the address and press .

123-456-7890
STO **Menu** ▶

Address: __
Auto: 01
STO **Option** ▶

#07 Stored
98 Empty
1 Used

Automatic Storing into Phonebook

This feature automatically stores a number into the first available phonebook memory address, indicating the location in the display. This prevents the possible overwriting of a previously stored number.

1. Enter the phone number.
2. Press the key under **STO** four times and press .

Example: To store the phone number 1 2 3 4 5 6 7 8 9 0 into a vacant memory address 01.

1. Press and hold .
2. Enter .
3. Press the key under **STO** three times.
4. Press the key under **STO** and press .

123-456-7890
STO **Menu** ▶

Address: __
Auto: 01
STO **Option** ▶

#01 Stored
97 Empty
2 Used

Auto Hyphenation

Automatically inserts hyphens when telephone numbers are entered and recalled from the phonebook. See **Auto Hyphenation (F23)** on page 74 to activate or deactivate this feature.

Length of Number	Display Example
10 digits or less	123-456-7890
11 to 21 digits	1-234-567-89012
22 digits or more	No hyphens

Note: When you manually insert hyphens, the “Auto Hyphenation” feature will not work for that particular number.

Manual Hyphenation

You can manually insert a hyphen at any place when you enter a telephone number. The maximum number is 32 digits long including hyphens.

Example: To insert a hyphen in the number 1 2 3 4 5 6 7 to display it as 123-4567.

1. Enter **1** **2** **3**.



2. Press **F** and scroll to “Manual Hyphen”.

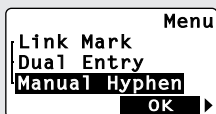

3. Press **F**.



4. Enter **4** **5** **6** **7**.

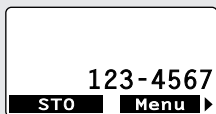

Tip: The screen may display dual prompts such as **Menu** ▶. This means that pressing the **F** key operates the same as pressing the key under **Menu**.

Storing Dual Numbers

The Dual Mark “\” can be used to store Dual Numbers. Up to 40 digits in addresses 01-90 and 80 digits in addresses 91-99.

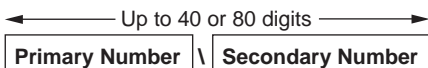

To store two telephone numbers in one phonebook address, enter the first number, select the Dual Mark “\” by using the menu, then enter the second number.

Example: To store the primary number 1 2 3 4 5 6 7 8 9 0 and the secondary number 9 8 7 6 5 4 3 2 1 0 in address 08.

1. Enter **1** **2** **3** **4** **5** **6** **7** **8** **9** **0**.

123-456-7890
STO Menu ▶

2. Press **F▶** and scroll to “Dual Entry”.

Menu
Link Mark
Dual Entry
Manual Hyphen
OK ▶

3. Press **F▶**.
The Dual Mark “\” is inserted.

Primary
1
23-456-7890\
STO Menu ▶

4. Enter **9** **8** **7** **6** **5** **4** **3** **2** **1** **0**.

Secondary
987-654-3210
STO Menu ▶

5. Press the key under **STO** three times.

Address: __
Auto: 02
STO Option ▶



6. Enter the address **0** **8** and press **F▶**.

#08 Stored
96 Empty
3 Used

Note: You can add a second number after storing a first number. See **Entering a Second Number** on page 46.

Storing a Name with a Phone Number

To use this procedure, you will need to refer to “**Entering Letters and Symbols**” on page 32.

1. Enter the phone number.
2. Press the key under **STO**.
3. Enter the name.
4. Press the key under **STO** twice, then enter the memory address (01 through 99) and press   to store the number with the name into memory.

Example: To store the phone number 1 2 3 4 5 6 7
8 9 0 with the name Jill into memory
address 11.

1. Enter the phone number;









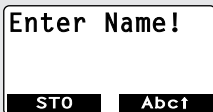



123-456-7890
STO Menu ▶

2. Press the key under **STO**.



Enter Name!
STO Abc†

3. Enter the Name;

 for “J”,
   for “i”,
    for “l”,
and    for “l”.

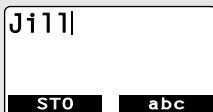



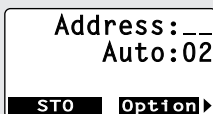

Jilll|
STO abc

4. Press the key under **STO** twice.



Address: __
Auto: 02
STO Option ▶

5. Enter the address  
and press  .

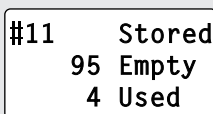

#11 Stored
95 Empty
4 Used

Note: To enter names into the phonebook in the Alpha mode you can use the alphabet that you selected with **Language Selection (F24)** on page 74.

Storing E-Mail Addresses

E-mail addresses up to 48 characters long can be stored in the Phonebook.

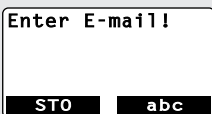

Example:

1. Enter a phone number and press the key under **STO** twice. Enter e-mail address.



2. Press the key under **STO**.



3. Press the key under **STO** and press   to store it.

Note: To add an e-mail address after storing numbers, see “**Modify**” menu on page 46.

Marking Numbers with Icons

Before storing, numbers can be marked with icons from the “**Option**” menu.

Example:

1. Enter phone number(s) and e-mail address.



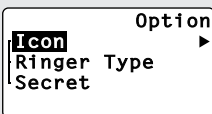

2. Press the key under **Option**.

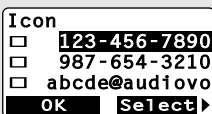

3. Press  and scroll to a number to be marked.



4. Press  and scroll icons with .



5. Press the key under **Set**.

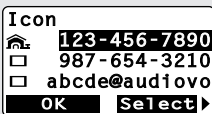

6. Repeat steps 3 through 5 for other numbers.

7. Press the key under **OK** to return to step 1 for other options.

Note: To add icons after storing numbers, see “**Modify**” menu on page 46.

Storing a Ringer Type with the Phone Number

To distinguish callers from each other, assign one of 15 different ringer tones to each Phonebook number. The ringer type is selected under the “**Option**” menu before storing.

Example:

1. Enter phone number(s), and press the key under **STO** three times.



2. Press **F▶** and scroll to “**Ringer Type**”.

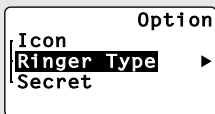

3. Press **F▶** and scroll to one of the numbers you want to set.

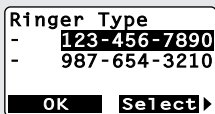

4. Press **F▶** and scroll to sample the different ringer types.

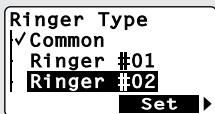

5. Press **F▶** to set the new ringer type.

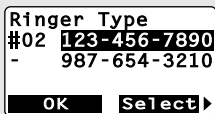

6. Press the key under **OK**.

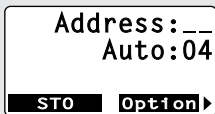

7. Press the key under **STO** and press **▼** **F▶**.

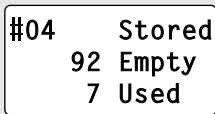

Note: The “**Common**” shown in the step 4 is the ringer type you selected with the Function Menu. See **Ringer Type Selection (F32)** on page 75.

Overwrite Warning

When you attempt to store an address in a location already being used, the “**Overwrite**” warning appears on the screen.

Example: To store the number 9 8 7 6 5 4 3 2 1 0 in the address 07, where another number 1 2 3 4 5 6 7 8 9 0 is already stored.

1. Enter **9** **8** **7** **6** **5** **4** **3** **2** **1** **0**.

987-654-3210
STO **Menu** ▶

2. Press the key under **STO** three times.

Address: __
Auto: 05
STO **Option** ▶

3. Enter **0** **7**.
The currently stored number flashes.

123-456-7890
#07 is used.

4. Two seconds later.

Overwrite?
Yes
No
OK ▶

5. If you accept to overwrite, scroll to “**Yes**” and press **F▶**.

6. If you do not want to overwrite, scroll to “**No**” and press **F▶**. The screen returns to the step 2 again.

Recall Menu

Press . This menu helps to recall a number from memory.

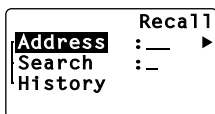

- **Address** : Address mode
- **Search** : Sort Scroll or Key Word Search Mode
- **History** : Call History Mode

Recall Menu Tree

Main Menu Sub-menu

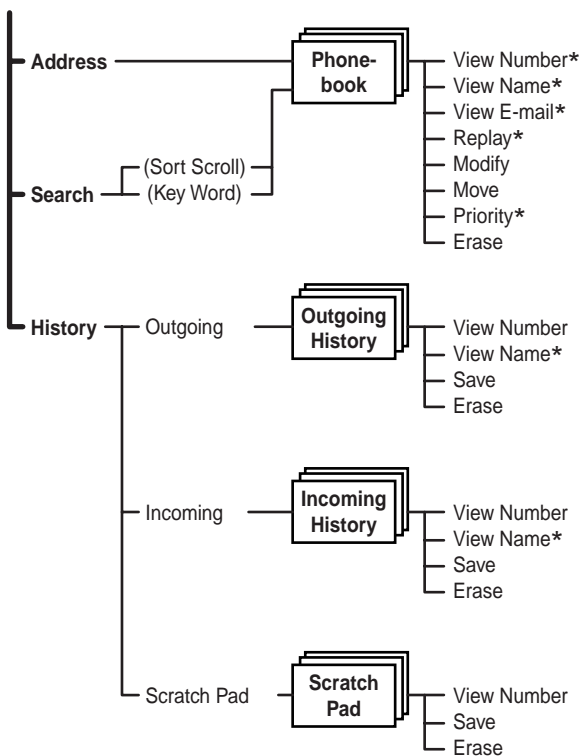

Note: The sub-menus marked with * will be available on the screen, if the corresponding items are stored in that address.

Phonebook Recall

Stored numbers can be recalled three ways: Address Mode, Sort Scroll Mode and Key Word Search Mode.

Phonebook Address Mode

Finds a phone number by recalling a specific address or by scrolling the phonebook.

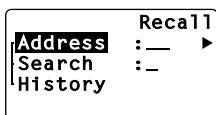

1. Press .
2. Enter the two-digit Memory Address.

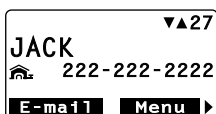

3. The phone number is displayed.

Example:



4. Press  or  to scroll.

Note: The scroll feature will skip any vacant memory address(es).

Phonebook Sort Scroll Mode

Alphabetically sorts and displays stored telephone numbers.

Example: To display the numbers stored in the memory alphabetically from “J”.

1. Press  and press  and press  for “J”.

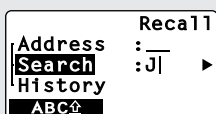

2. Press .



3. Press .

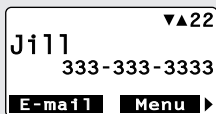

4. Press .

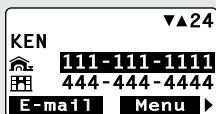

Note: This mode will sort and display names disregarding the initial spaces if applied.

Phonebook Key Word Search Mode

Searches and displays a character string of any part of an Alpha Tag stored in the phonebook.

Example: To search the character string AN stored in the phonebook.

1. Press   and press  for "A".

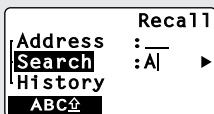

2. Press   for "N".

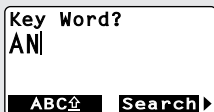

3. Press .

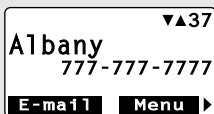

4. Press .

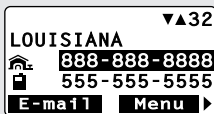

5. Press  .

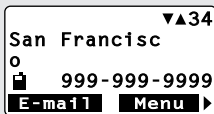

6. Press .

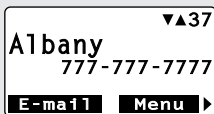

7. Press .

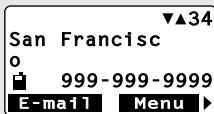



Note: The key word can be searched regardless of upper or lower case letters.

Tip: In the three recall modes, long names and phone numbers are displayed in the short form: the first 12 characters of a name and the last 12 digits of a number.

Dialing Dual Numbers

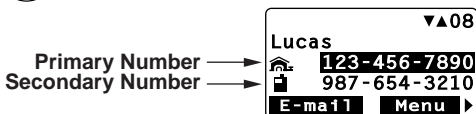

A displayed number can be called by pressing .

- Press  to dial the primary number.
- Press ,  to dial the secondary number.







Reviewing Long Names and Numbers

Allows you to review entire Alpha Name Tags or long numbers stored in the phonebook.

1. Use any of the previously described phonebook search modes to recall a number.
2. Press  and scroll to “View Number” or “View Name”. Press  again.

Locating E-mail Addresses

1. Use any of the previously described phonebook search modes to recall a number.
2. Press the key under **E-mail**.
3. Press  or  to scroll e-mail addresses.
4. To view long e-mail address, press  and scroll to “View E-mail”. Press  again.



Prepending Dialing

This feature will be convenient when you need to add an area code to the number in the phonebook.

Example: To add 1 2 3 to a number 4 5 6 7 8 9 0.

1. Recall the number.

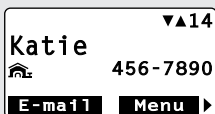

2. Enter   .

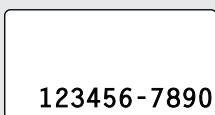

3. Press . Then the call is placed to 123-4567890.

Note: Extra digits will not be stored in memory.

Phonebook Edit

Modifying Numbers and Names

Any phonebook contents can be modified including numbers, names, e-mail addresses, icons, ringer types, secret and phonebook addresses.

Modifying Phone Numbers

Recall the number from the phonebook.

Press **(F>)** to select “Menu”, then scroll to “Modify” and press **(F>)**. Enter the new digit(s) then press **(CLR)** to delete the previous numbers.

Modifying Alpha Name Tags

Recall the number and proceed to “Modify” as above.

Press the key under **STO**, and the Name Tag will appear by itself. Press **(CLR)** to clear the letter(s), and enter the new Name.

Modifying Phonebook Addresses

After modifying a number/name, press the key under **STO** without entering a new address and press **(v)**, **(F>)**. This overwrites the current phonebook address. If you enter a new address, the modified number/name will be saved to the new address and the original address information will remain unchanged.

Entering a Second Number

Example:

1. Recall the number stored in the memory address.

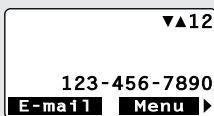

2. Press **(F>)** and scroll to “Modify”.

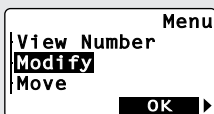

3. Press **(F>)**.



4. Press the key under **Menu** and scroll to “Dual Entry”.

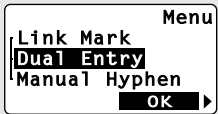

5. Press **F**.
The Dual Mark “\” is inserted.

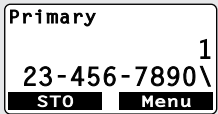

6. Enter the second number.

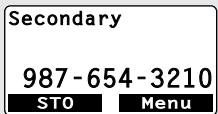

7. Press the key under **STO** three times.



8. Press the key under **STO** and press **↓** **F** to store in the original address.

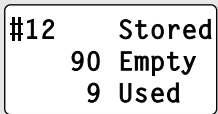

Moving Numbers and Names

Phonebook contents can be moved to a new location, erasing the original address.

Example: To move information stored in address 20 to address 15.

1. Recall the number stored in address 20.

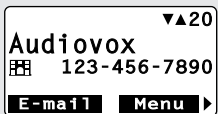

2. Press **F** and scroll to “Move”.

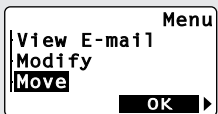

3. Press **F**.



4. Enter the new address **1** **5**.

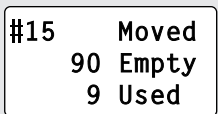

Changing Priority of Dual Numbers

The primary and the secondary numbers of a phonebook address can be interchanged. The submenu “**Priority**” will only be available when two telephone numbers are stored in that address.

Example:

1. Recall the number.

Primary Number →
Secondary Number →

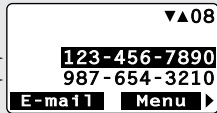

2. Press **F▶** and scroll to “**Priority**”.



3. Press **F▶**.

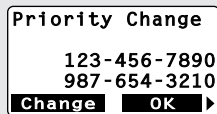

4. Press the key under **Change**. The new priority is displayed.

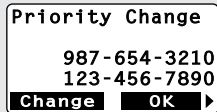

5. Press **F▶** to confirm.

Note: The primary number will be dialed when you use **Speed Dialing** and **Quick Dialing** features.

Erasing Numbers and Names

Example:

1. Recall the number.

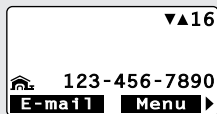

2. Press **F▶** and scroll to “**Erase**”.



3. Press **F▶**. The number is shown again. Press **F▶**.

4. Two seconds later the screen is changed.



5. To erase the number scroll to “**Yes**”, otherwise “**No**”, and press **F▶**.

Secret Memory

Storing a Secret Number

Allows you to store a phone number or e-mail address that you want to keep secret in your phonebook and can only be accessed by entering the **Security Code** (see page 71).

Example: To store the phone number 1 2 3 4 5 6 7 8 9 0 in address 30 as a secret number.

1. Enter **1** **2** **3** **4** **5** **6** **7** **8** **9** **0**.

123-456-7890
STO Menu ▶

2. Press the key under **STO** three times.

Address: __
Auto:10
STO Option ▶

3. Press **F▶** and scroll to "Secret".

Option
Icon
Ringer Type
Secret ▶

4. Press **F▶**. Scroll to a number to be secret for two numbers or more.

Secret
123-456-7890
OK On/Off ▶

5. Press **F▶**. The number turns "Secret".

Secret
Secret
OK On/Off ▶

6. Press the key under **OK**.

Address: __
Auto:10
STO Option ▶

7. Enter the address **3** **0** and press **▼** **F▶**.

#30 Stored
80 Empty
19 Used

Note: Each of the phone numbers and e-mail address can be marked secret by repeating steps 4 and 5.

Recalling a Secret Number

Example: To recall the number 1 2 3 4 5 6 7 8 9 0 stored in the address 30.

1. Use Phonebook Search Mode to recall a secret number.



2. Press .

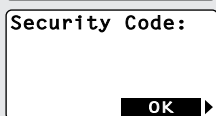

3. Enter the four-digit security code and press .

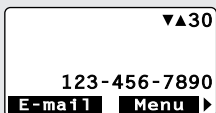

Link Dialing



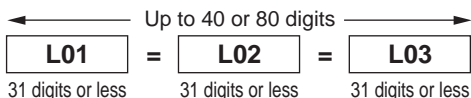

Allows you to sequentially link groups of numbers and store them in memory. When dialed, the first group of numbers will be sent in digital signaling, and the rest of the numbers will be sent in Touch Tone™, group by group each time you press .

Storing Linked Numbers

You can store Linked Numbers with Link Marks “=” up to 40 digits for the address 01 to 90, and up to 80 digits for the address 91 to 99 in the phonebook.



The example on the next page shows how to store a Linked number at a specific memory address.

1. Enter the first number.
2. Press  . A link mark “=” will be added at the end of the number.
3. Enter the second number. If you wish to link additional number(s), return to step 2.
4. Press the key under **STO** three times, then enter the memory address (01 to 99). Press  .

Example: To link 3 numbers and store in Address 35.

1. Enter the first number.

987-654-3210
STO Menu ▶

2. Press .

Menu
Link Mark
Dual Entry
Manual Hyphen
OK ▶

3. Press .

Link01
9
87-654-3210=
STO Menu ▶

4. Enter the second number.



Link02
456
STO Menu ▶

5. Press  .

Link02
456=
STO Menu ▶



6. Enter the third number.

Link03
1234567890
STO Menu ▶





7. Press the key under **STO** three times. Enter the address   and press

 .

#35 Stored
90 Empty
9 Used

Note: While entering a linked number, you may review all the parts of that number, even those already entered. Press , scroll to “**View Number**” and press . The linked numbers you have just entered will be displayed one by one each time you press .

Placing Calls Using Linked Numbers

1. Press , and select the linked number you want to call. (See **Phonebook Recall** on page 43.)
2. Press . The  indicator will light as the first number is dialed.
3. Press . The second linked number will be sent in Touch Tone™ signals. Succeeding numbers can be sent sequentially by pressing  again.

Voice Activated Dialing (VAD)

Allows you to call to a saved phone number by just saying the name. You can register, in your own voice, names for up to 20 numbers.

Voice Registration

Example: To store the telephone number 1 2 3 4 5 6 7 8 9 0, and register the name "Katie".

1. Enter the telephone number (1 2 3 4 5 6 7 8 9 0).
2. Press the key under **STO** four times.

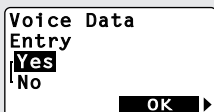

Voice Data
Entry
Yes
No
OK

3. Press .

4. After you hear the voice prompt, "**Name, please**", speak "Katie" into the microphone of the handset.



Voice Dial
Data Entry

You will hear back "Katie" repeated from the handset.

5. After you hear the voice prompt, "**Again**", repeat the name "Katie". You will hear "Katie" repeated from the handset again.
6. If the registration is successful, you will hear the prompt "**Entry Completed**".
7. Your voice registration status is displayed.

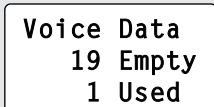

Voice Data
19 Empty
1 Used

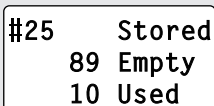

8. And your phonebook status is displayed.



#25 Stored
89 Empty
10 Used

- Notes:**
1. Register names in your normal voice tone and in a quiet environment.
 2. For better recognition, similar sounding names should not be registered.
 3. Maximum recording length is 2 seconds.
 4. The same person's voice that was used to record the names must be used for dialing, otherwise the VAD feature may not work properly.

Replaying Registered Voices

1. Press  to recall the number.
2. Press , scroll to “**Re-play**” and press  again.
3. You will hear the registered name.

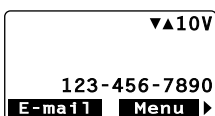

Note: Addresses with voice are marked with “V”.

Voice Activated Dialing





Example: To dial the number by speaking “Katie”.

1. Press and hold .
2. When the phone says “**Name, please,**” say “Katie” into the microphone.
3. You will hear “**Calling Katie**” and the number will be automatically dialed.

Notes: 1. If you hear “**Did you say ‘Katie’ ?**”, answer “Yes” or “No”.





2. If using this feature through a car kit option, speak slightly louder for better recognition.

Adding Voice to Stored Numbers

1. Press  to recall the number.
2. Press , scroll to “**Modify**” and press  again.
3. Press the key under **STO** four times.
4. When “**Voice Data Entry**” appears on screen, press  and go to step 4 of **Voice Registration** on page 52.

Note: With stored dual or linked numbers, the primary number can be dialed using VAD.

Deleting Registered Voices

1. Press  to recall the number.
2. Press , scroll to “**Erase**” and press  again.
3. Scroll to “**Voice Data**” and press .
4. When “**Voice Data Erase?**” appears on screen, scroll to “**Yes**” and press .

Call History

Recalls outgoing Call History and incoming Caller ID numbers and conveniently redials recently called numbers or missed calls by using the stored Caller ID. (See **Caller ID with Name** on page 28.)

Call History Memories

Memory	Description
Outgoing	10 previously dialed numbers. Addresses 01 to 10.
Incoming	10 previously answered or missed calls. Addresses 01 to 10.
Scratch Pad	3 previously written numbers. Addresses 01 to 03.

You can access the memory in two ways, Scroll and Shortcut.



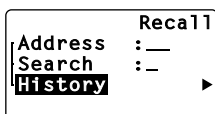

By Scrolling

1. Press  and scroll to "History".







2. Press  and scroll to the menu item you want.



3. Press  to select.
4. To review the numbers in memory, scroll with  or .
5. Press  to dial displayed number.

Shortcut:

- Press   to display the latest number in the outgoing history memory.
- Press   to display the latest number in the incoming history memory.

Reviewing Outgoing Call History

Example: To recall a number from Outgoing History.

1. Press  .

The most recent call is displayed.

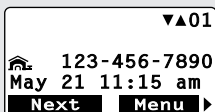

2. Scroll with  or  to review other numbers.
3. Press  to dial displayed number.

When duplicate numbers are called, only the latest call is stored in the call history.

Reviewing Incoming Call History

Example: To recall a received Caller ID from Memory Stack.

1. Press  .

The most recent call is displayed.

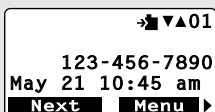

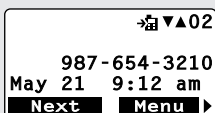

2. Press .



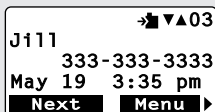

3. Press .

A name is shown, if available in your phonebook.





4. Press  to dial displayed number.

In the incoming call history, numbers marked with  represent missed calls and numbers marked with  represent answered calls. When duplicate numbers are received, only the latest call is stored in the call history.

Reviewing Scratch Pad

Example:

1. Press  and scroll to "History".
2. Press  and scroll to "Scratch Pad".
3. Press .



4. Scroll with  or  to review other numbers.
5. Press  to dial displayed number.

Saving a Number to Phonebook

Numbers in the Call History and Scratch Pad Memory can be stored in your phonebook.

Example: To save a received Caller ID to your phonebook.

1. Recall a number.

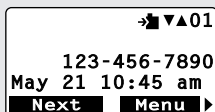

2. Press  and scroll to "Save".

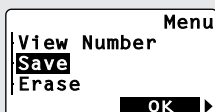





3. Press .

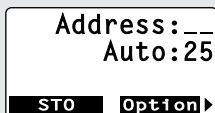

4. Press the key under **STO** three times.



5. Enter   as the address and press  .

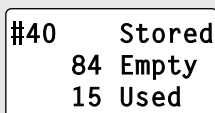

See **Modifying Numbers and Names** on page 46 to add a name.



MESSAGING FEATURES

Your 9155-GPX Audiovox Cellular Telephone features Two-Way Short Message Service (SMS) that sends and receives Text Messages through your phone. The phone also supports Voice Mail Notification.

Please note that operation of these features depends on the Cellular System and therefore may not be available in all areas. To inquire about availability or to subscribe to these services, please contact your service provider.

Message Indicator

A message indicator  displays the current state of received messages at the upper right of the screen.

 Flashing	New "Urgent" Text Messages or Voice Mail Notifications
 Steady	New Text Messages or Voice Mail Notifications
 off	No New Text Messages nor Voice Mail Notifications

Message Menu

The "Message" main menu appears by pressing .

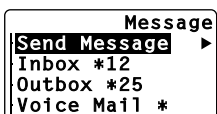

- **Send Message:** Creates and sends messages.
- **Inbox:** Checks received messages.
- **Outbox:** Reviews sent messages.
- **Voice Mail:** Displays Voice Mail Notification.
- **Settings:** Customizes messaging features.
- **Address Entry:** Shifts to the phonebook mode to enter e-mail addresses.

- Notes:**
1. " * " flashes when new messages or Voice Mails are available.
 2. " * " flashes when unsent draft messages remain in the Outbox.
 3. The number next to the Inbox and Outbox is the number of messages each contains.
 4. Press and hold  to open "Inbox."

Receiving Text Messages

Your phone can receive and display a text message of up to 255 characters, and saves up to 30 messages in the Inbox.

When a new text message is received, the  indicator appears and the screen displays “**New Message**” with animation. Depending on the settings, the phone may also sound a short beep tone.





Checking Received Messages

1. Press and hold  to open “**Inbox**”.
2. The **Inbox** lists the received messages with sender name or number.

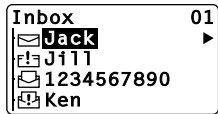
Example:



3. Scroll the list, and press .
4. Each time you press  the screen displays the time stamp, sender, call-back number (if available), and message.
5. To view Inbox Option, press the key under **Option**.
6. To return to the list, press the key under **OK**.

Notes: 1. The sender name appears the same as it does in the phonebook.

2. The following icons mean:

 : **New Text** not yet viewed

 : **Old Text** already viewed

 : **Urgent new text**

 : **Urgent old text**

3. To dial a callback number, press the key under **Send** when the number appears.

4. This feature receives only English letters.

Inbox Option

- **Reply:** Shifts to **Send Message** mode to reply to the message. *This feature may not be available at all locations.*
- **Forward:** Shifts to **Send Message** mode to forward the received message.
- **Erase:** Erases the received message.
- **Save Address:** Saves the sender's address and callback number in your phonebook.
- **Search:** Searches phone number(s) and e-mail address(es) in a received message for either saving into the phonebook, placing a call or sending a message.

Sending Text Messages

While operating in the digital mode, your phone can send a text message to up to 10 recipients with a cellular phone number or e-mail address. The phone saves up to 30 messages in your Outbox.

Sending Text Messages

1. Press  and  to enter "Send Message" menu.

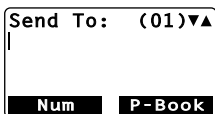

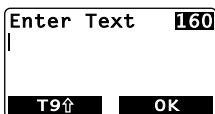

2. Enter the cellular phone number or e-mail address. You can also recall it from your phonebook by pressing the key under **P-Book**.

3. Press the key under **OK** and enter your message.



4. Press the key under **OK**. The menu appears for editing your message.



5. To send the message, press  or the key under **Send** while the  indicator is on.

6. "Sending Mail" appears with animation.



7. Depending on the settings, the message may be saved in the Outbox.



- Notes:**
1. To specify two or more recipients, press  after step 2, and repeat the same step.
 2. To enter your text, see **Entering Letters and Symbols** on page 32.
 3. The maximum message length is 160 characters and that includes the text message and the e-mail address. It may be shorter depending on your service provider.
 4. This feature sends only English letters.
 5. If attempted in the analog mode, your message will be saved in Outbox without being sent.
 6. If you answer an incoming call while you are creating a message, it will be saved in Outbox as a draft.

Send-Message Menu

- **Edit Send To:** Corrects address.
- **Edit Text:** Corrects message.
- **Priority:** Marks message “**Urgent**”.
- **Call Back # :** Temporarily changes your call back number for current message.
- **Delivery Ack:** Temporarily changes acknowledgment mode for current message.
- **Save to Outbox:** Saves message as a draft and exits from the messaging feature.



Note: See also **Default Call Back #** and **Default Delivery Ack** under **Messaging Feature Settings** on page 63.

Reviewing Sent Messages

1. Press , scroll to “**Outbox**”, and press .
2. The **Outbox** lists sent messages.

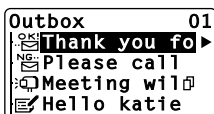
Example:



3. Scroll the list, and press .
4. Each time you press  the screen displays the time stamp, recipient, call-back number (if available), and message.
5. To view Outbox Option, press the key under **Option**.
6. To return to the list, press the key under **OK**.

Notes: 1. The list displays the first 12 characters of each message.

2. The following icons mean: (icon descriptions are fine)

 : Message **sent** already

 : Message **failed** to send

 : Message **delivered** successfully

 : Message **saved** as draft

 : For two or more recipients.

Outbox Options

- **Edit:** Shifts to **Send Message** mode to edit the message.
- **Resend:** Resends the message to the same address while the  indicator is on.
- **Erase:** Erases the message.

Voice Mail

In order to use voice mail, you must first activate your voice mailbox. For information on how to do this, please contact your service provider.



Voice Mail Notification

The voice mail system sends a notification to your phone when new messages are left in your voice mailbox.

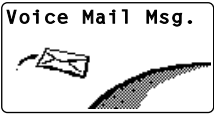
Receiving Voice Mail Notification

1. When a new voice mail notification is received, the  indicator appears and the screen displays “**Voice Mail Msg.**” with animation. Depending on the settings, the phone may also sound a short beep tone. 
2. To see how many messages are in your voice mailbox, see **To Display Number of Voice Mail Messages** below.
3. To listen to your voice mail messages, see **Voice Mail Dialing** on the following page.

To Display Number of Voice Mail Messages

1. Press , scroll to “**Voice Mail**”, and press .
2. The screen displays the number of messages in your voice mailbox.

Example:

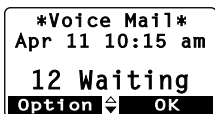



3. Press  to view additional information.
4. To erase the voice mail notification, press the key under **Option** and select “**Erase**”.

Voice Mail Dialing







Storing the Voice Mail Access Number

To make a set of linked numbers, please see **Storing Linked Numbers in Phonebook** on page 50, and follow the steps 1 through 3. Press the key under **STO** three times, and press  to store. Up to 80 digits of linked numbers can be stored including the link mark “ = ”. A Name Tag (up to 24 characters long) can be added to your voice mail number. (See **Storing a Name with a Phone Number** on page 38.)

Calling Your Voice Mail

1. Press and hold . The first number will be displayed and dialed.
2. Press . The second number will be displayed and sent in Touch Tone™ signal.
3. The succeeding numbers can be sent sequentially by pressing .

Reviewing the Voice Mail Access Number

1. Press  to select the Phonebook Address Mode.
2. Press   . The first linked number in  will be displayed.
3. Press  (one or more times) to display the remaining linked numbers in .

Messaging Feature Settings

The following menu allows you to customize your phone's Text Messages and Voice Mail Notification features.





Default Call Back

Enter the default callback number that will be added to all outgoing text messages. For your convenience, your phone number has been preset as the callback number. To change it for an individual message, see **Send-Message Menu** on page 60.

Default Delivery Ack

When sending a text message you can request a delivery acknowledgment when the recipient receives the message.

Select one of the following modes as default. To change it for an individual message, see **Send-Message Menu** on page 60.

- **Enhanced Ack:** When the acknowledgment is received, the phone displays "**Delivered!**" with the time stamp and recipient, and it also turns the icon  (sent) into  (delivered) in the Outbox.
- **Normal Ack:** When the acknowledgment is received, the phone turns the icon  (sent) into  (delivered) in the Outbox.
- **No Ack:** No acknowledgment is requested.

Note: *The "Delivered!" is displayed for the messages that have been saved in the Outbox.*

New Message Alert

Select one of the settings below as a new message alert:

- **Alert On:** Short beep tone sounds once.
- **Alert Off:** Alert does not sound.
- **Vibrate Only:** Vibrating alert only.
- **Reminder:** Short beep tone sounds every 2 minutes while animation is displayed.

Voice Mail Alert

Select one of the settings below as a new voice mail message alert:

- **Alert On:** Short beep tone sounds once.
- **Alert Off:** Alert does not sound.
- **Vibrate Only:** Vibrating alert only.
- **Reminder:** Short beep tone sounds at every 2 minutes while animation is displayed.

Text Entry Mode

Select the text entry mode that first appears when entering a message.

- **T9 Mode:** “T9” appears first, then, “**Abc**”, “**Num**” and “**Sym**”.
- **Alpha Mode:** “**Abc**” appears first, then, “**T9**”, “**Num**” and “**Sym**”.

Save Sent Message

Select whether or not to save sent messages.

- **Auto Save:** All messages are saved in the Outbox.
- **Prompt:** The phone prompts you to choose it for every message.
- **Do not Save:** No message is saved.

Erase All Text Messages

Erases all saved messages in the Inbox and Outbox.

SMS Text Lines Selection

You can select to have the text messages displayed in 4 or 6 lines for the Inbox and Outbox.

SMS Memory Management

Selects Inbox Memory Management.

- **Auto Delete:** If the Inbox is full, it deletes the oldest text message to save a new text message.
- **Warning Msg.:** If the Inbox is full, it will not save any new text message and “**Memory Full, New Text Rejected**” will display.

Note: *The Outbox always functions in **Auto Delete** mode.*

Reply with Copy

Automatically attaches a copy or part of the incoming message to your reply.

- **Yes:** Reply with copy
- **No:** Reply without copy

When “**Yes**” is selected, the phone replies to a message by attaching “Message was:” and copying the first 20 characters of the received message.

Note: *See the **Reply** menu in **Inbox Option** on page 58.*

WEB BROWSING

Your 9155-GPX Audiovox Cellular Telephone can directly access various Internet websites if you subscribe to Internet service through your service provider. It also supports network services such as e-mailing with the web browser. Please contact your service provider for the availability of these services.





Accessing Internet

Your phone is able to access the Internet while it operates in the digital mode, as indicated by the  indicator.

Starting a Web Browser







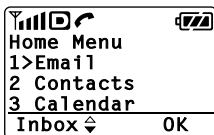

1. Press the key under **Web** on standby to enter “Web Menu”.



2. Scroll to “Internet”, and press .
3. The Web Browser will start. The cached information may be displayed.
4. To access the Internet, press and hold  while  indicator is on. Your phone will display your service provider’s home page with a flashing .

Example:



5. Scroll the page by  or .
6. Press  or  to select the menu option in the bottom line of the display.
7. To return to the previous page, press  or .
8. Press  to terminate the network connection. The  indicator will disappear, but you can still browse the cached information.
9. Press  again to close the web browser.



Browser Menu

To view the browser's local menu, press **(v/4)** key while it is active. The menu will always appear in English.

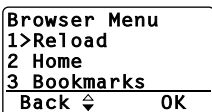

1. **Reload**: Reloads current page.
2. **Home**: Returns to Home page. Press and hold **(CLR)** to do the same thing.
3. **Bookmarks**: Displays bookmarks.
4. **Mark Site**: Stores current page in bookmark list.
5. **About Openwave**: Displays browser version.
6. **Advanced**:
 - **Show URL**: Displays the URL (Uniform Resource Locator) of the current page.
 - **Homepage**: Changes home page.
 - **Set WAP Proxy**: Selects network server.
 - **Restart Browser**: Clears the browser's cache memory.
 - **Encryption**: Use for security.

Note: Altering "**Homepage**" and "**Set WAP Proxy**" settings may disable web access.

E-mailing with Browser

The Web Browser allows you to send and receive e-mails directly through your phone. Please contact your service provider for details of the service.

Receiving E-mails

When e-mail arrives at your mailbox, an alert is sent to your phone.

1. The web browser will automatically start when you receive an e-mail and will notify you on the screen.

Example:

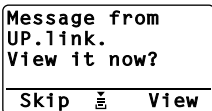

2. To access your service provider's home page and view your e-mail press the key under "**View**."
3. If you select "**Skip**", the alert is saved to the Alert Inbox.

Checking Alert Inbox

When your Alert Inbox saves alerts, the screen turns **Web** into **Web** at its bottom. It saves up to 9 alerts.

1. Press the key under **Web** to enter “**Web Menu**”.
2. Press  to open “**Alert Inbox**”.

Example:

Alert Inbox	
1>Email	
2 Calendar	
Erase 	View

3. To access your service provider’s home page and view your e-mail press the key under “**View**.”

Sending E-mails

You can send an e-mail message of up to 512 characters (this may be shorter in length depending on your service provider).

1. To access your service provider’s home page follow steps 1 through 4 in **Starting a Web Browser** then select the e-mail menu.
2. While connected to the home page, enter address and message. To enter letters, see **Entering Letters and Symbols** on page 32.

Note: English letters are always used when sending messages.

Web Browser Settings

Your cellular telephone is already programmed for Internet service that may be available from your Service Provider. You can customize your browser with the following four menus only.

Web Lock

Prevents unauthorized Internet access by locking the browser. Your four digit Security Code unlocks the browser.

Web Backlight

While browsing you can turn the backlight setting on/off. Select “**30sec.**” (5s to 99sec), “**Off**” or “**Always On**” from the menu.

Web Idle Timer

Web access can be automatically terminated if there is no network activity within a specified period of time. Set the timer between “**0min.01sec.**” and “**9min.59sec.**” To deactivate this feature, set the timer to “**0min.00sec.**”

Confirm — Connect Prompt

You can turn on/off a prompt “**Set up Connection?**” for accessing the Internet.

Connection Settings

Never use the following "Connection" menus to change any phone settings unless otherwise instructed by your carrier. Altering any of these settings may disable Web access capability.

Your phone can have up to 4 sets of the server IP (Internet Protocol) addresses and Port numbers to access your service provider's website. These may already be preset or be advised by your service provider.

To change the settings, enter your 4-digit Security Code.

Changing IP addresses in "Web Link A"

1. Scroll to "Web Link A" and press **F▶**.
2. Enter **Link A Primary IP Address** and press **F▶**.
3. Enter **Link A Primary Port number** and press **F▶**.
4. Enter **Link A Secondary IP Address** and press **F▶**.
5. Enter **Link A Secondary Port number** and press **F▶**.

Changing IP addresses in "Web Link B"

Scroll to "Web Link B" and press **F▶**, and follow the above steps 2 through 5 for **Link B**.

- Notes:**
1. An IP address must be 12-digit long to enter. If you have, for example, 123.45.67.8, then enter **1** **2** **3**, **0** **4** **5**, **0** **6** **7**, **0** **8**.
0 **4** **5**, **0** **6** **7**, **0** **8**.
 2. Your phone may display the stored IP addresses or Port numbers in the above steps. Then press **F▶** to keep them unchanged.

QNC Info.

The "Username" and "Password" are normally blank. The "Auth.Type" is normally set to "None". Altering any of these settings may disable the Web access.

Packet Info.

To enable accessing with packet mode, the "Username" and "Password" should be programmed as advised by your service provider. The "Auth.Type" is normally set to "Auto". Altering any of these settings may disable the Web access.

Current Link

This is normally set to "Web Link A". Altering to "Web Link B" may disable the Web access.

Service

This mode is normally set to "Auto". Altering to "Packet" or "QNC" may disable the Web access.

FUNCTION MENU

Accessing Function Menu



Customize your phone with the various phone settings in the Function Menu. See **Function Menu Tree** on the following page for more information.

You can reach the Function you want to access in two ways; Scroll and Shortcut.

By Scrolling

1. Press  to enter Main Menu.





2. Scroll with  or  key to the desired item in the Main Menu.

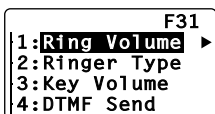

3. Press  to enter the submenu.



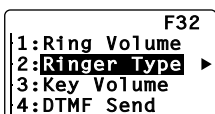

4. Scroll with  or  key to the desired item in the submenu.





5. Press  to enter the function.

By Shortcut

Each Function has its shortcut number for direct access. For example, to enter the function “Ringer Type” (F32), press   .

To Exit from Function Menu

- To return from a submenu to the main menu, press .
- To exit from Function Menu, press .

Notes: 1. “▶” to the right of a menu indicates more detailed items can be viewed by pressing .

2. “✓” shows the current function setting.

3. The screen may display dual prompts such as **OK ▶**. This means that pressing the  key operates the same as pressing the key under **OK**.

Function Menu Tree

Main Menu Submenu Branch

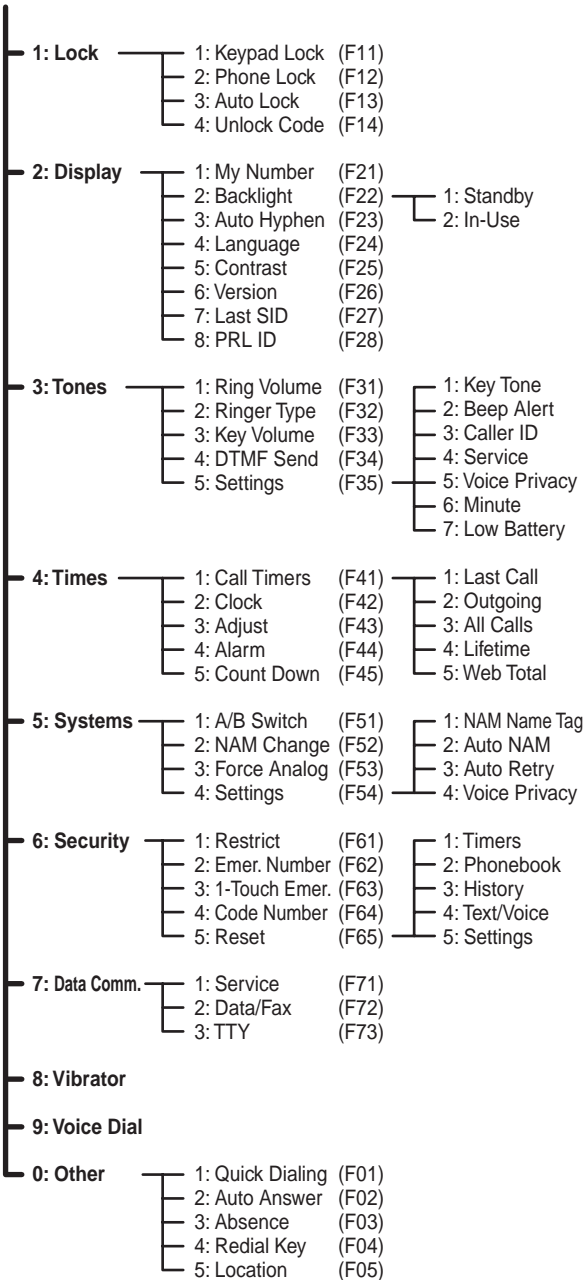

Lock Features

Security Code and Unlock Code

Your phone is equipped with a Security Code and a Unlock Code to access various security features. You may change the preset codes for added protection.

Code	Preset	Description
Security Code	1234	To access Secret Number, to set Call Restriction, etc.
Unlock Code	1234	To unlock the Phone

Enter your four-digit code when “**Security Code:**” displays.

Security Code:



OK

See **Changing the Security Code (F64)** on page 85.
See **Changing the Unlock Code (F14)** on page 72.

Keypad Lock (F11)

Prevents inadvertent pressing of keys (e.g. when phone is in purse or pocket).



When activated, the following functions are still available:

- Incoming calls can be answered with .
- Muting the ringer or stopping the vibrating with .
- Programmed emergency numbers can be called. (Except for **One-Touch Emergency Call.**)

When activated, the following functions are not available:

- Automatic Answering
- Any Key Answering
- One-Touch Emergency Call
- Quick Dialing
- Turning off the phone by .



To Activate/Deactivate this Feature:

1. Press    to activate “**Keypad Lock**” mode.
2. Repeat steps again to deactivate.

Keypad Lock
May 20 Mon
3 : 36 pm

Phone Lock (F12)

Prevents unauthorized use of the phone. When activated the following functions are still available:

- Incoming calls can be answered with .
- Muting the ringer or stopping the vibrating with .
- Any Key Answering
- Programmed Emergency Call
- One-Touch Emergency Call
- Turning off the phone by .

When activated, the following functions are not available:

- Automatic Answering
- Quick Dialing

To Activate:



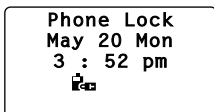

1. Press  **1**  to activate **“Phone Lock”** mode.



Note: The phone will remain locked even if the power is turned off.

Automatic Phone Lock (F13)

When this feature is activated, the phone automatically locks after it is turned off. (See **Phone Lock (F12)** above). To operate, the four digit unlock code must be entered.





1. Press  **1** .
2. You can turn this feature on/off by  or .
3. Press  to set.



Unlocking the Phone

1. Enter the four-digit unlock code.
2. The **“Phone Lock”** indicator will go out.

Changing the Unlock Code (F14)

1. Press  **1** .
2. Enter the four-digit security code and press .
3. The current unlock code will be displayed.
4. Enter a new four-digit unlock code and press .

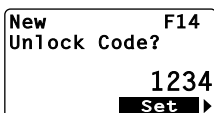

Display Features

Own Telephone Number Display (F21)

Enables you to display your own telephone number and the ID number (SID) of your “Home” Cellular System.

1. Press .
2. Press to exit.

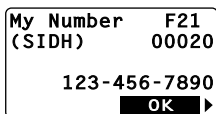

Backlight Control (Standby) (F22-1)

When the power turns on, the LCD display and keypad are automatically back lighted. To select the backlight duration:

1. Press .
2. You can change the current mode by or .
3. Press to set.



• 10 Seconds Mode

Backlight is on for 10 seconds after any key is pressed. It also lights automatically for an incoming call. To change the duration, press , enter a desired time (5 to 30 seconds) and press .

• Off Mode

Backlight is on momentarily when the power is first turned on, but remains off thereafter.

• Always On Mode

Backlight is always on.

Note: You can keep the backlight on while you are engaged in a conversation. See **Backlight Control (In-Use) (F22-2)** below.

Backlight Control (In-Use) (F22-2)

To keep the backlight on during phone calls, select the “Always On” feature by:

1. Press .
2. Scroll with or to “Normal” or “Always On”.
3. Press to set.

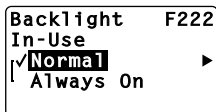

Auto Hyphenation (F23)

See **Auto Hyphenation** on page 36.

1. Press **F23** **2** **3**.
2. Scroll with **▲** or **▼** to "On" or "Off".
3. Press **F23** to set.

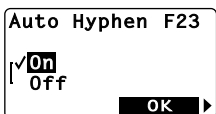

Language Selection (F24)

To select the language in which the menu options are displayed (English, Spanish, French or Portuguese):

1. Press **F24** **2** **4**.
2. Scroll with **▲** or **▼** to the desired language.
3. Press **F24** to set.

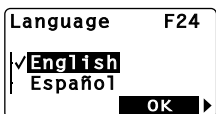

Contrast Control (F25)

The LCD display contrast can be adjusted in 7 steps to suit your taste.

1. Press **F25** **2** **5**.
2. Adjust the contrast with **▲** or **▼**.
3. Press **F25** to set.

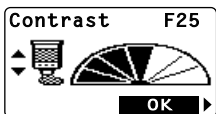

Software Version Display (F26)

To display the software version installed on the phone:

1. Press **F26** **2** **6**.
2. Press **F26** to exit.

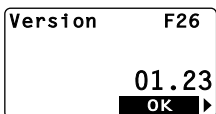

Last Rescan SID Indicator (F27)

To display the **System Identification Number (SID)** the phone is currently using:

1. Press **F27** **2** **7**.
2. Press **F27** to exit.

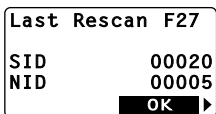

PRL ID Review (F28)

To display the **Preferred Roaming List (PRL)** version programmed in the phone:

1. Press **F28** **2** **8**.
2. Press **F28** to exit.

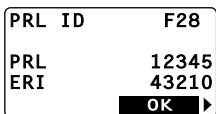

Volume and Tone Controls

Ringer Volume Control (F31)

To adjust the volume of the ringer/melody, **Clock Alarm** alert and the **Countdown Timer** alert:

1. Press **F** **3** **1**.
2. Keep pressing **▲** or **▼** until you get the desired sound level, or “**Silent**” mode.



Note: In **Silent** alert mode the ringer tone will not sound for an incoming call. However if Automatic Answering is ON, the ringer tone will sound at the lowest available volume.

Ringer Type Selection (F32)

To select a ringer tone pattern from 15 options including melodies:

1. Press **F** **3** **2**.
2. Press **▲** or **▼** to select the ringer tone.
3. Press **F** to set.

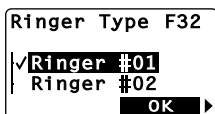

Key Tone Volume Control (F33)

1. Press **F** **3** **3**.
2. Keep pressing **▲** or **▼** until you achieve the desired sound level, or “**Silent**” mode.



Note: Key tone will be off in **Silent** mode, but tone will be heard on the other side of the line.

Sending DTMF (F34)

To activate/deactivate Sending DTMF (Touch Tone™) when you enter a number during a call:

1. Press **F** **3** **4**.
2. Scroll to “**On**” or “**Off**” to select.
3. Press **F** to set.

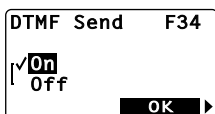

Key Tone Length (F35-1)

To select tone length when a key is pressed:

1. Press **F**, **3 DEF**, **5 JKL** and **1**.
2. Press **▲** or **▼** to change the current mode.
3. Press **F** to set.



- **Normal Mode**

Tone is heard as long as the key is being pressed.

- **Short Mode**

Tone is heard for a short time even if the key remains pressed.

Single Alert Beep Tone (F35-2)

This feature is used to signal an incoming call with only a single beep. This feature can only be used with the **Silent** alert mode. See **Ringer Volume Control (F31)** on page 75.

1. Press **F**, **3 DEF**, **5 JKL** and **2 ABC**.
2. Press **▲** or **▼** to turn this feature on/off.
3. Press **F** to set.



Caller ID Alert (F35-3)

To set an audible alert when a Caller ID call is received:

1. Press **F**, **3 DEF**, **5 JKL** and **3 DEF**.
2. Press **▲** or **▼** to turn this feature on/off.
3. Press **F** to set.

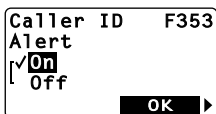

Service Mode Alert (F35-4)

To set an audible alert when the service mode changes from Digital to Analog or vice versa:

1. Press **F**, **3 DEF**, **5 JKL** and **4 GHI**.
2. Press **▲** or **▼** to turn this feature on/off.
3. Press **F** to set.



Voice Privacy Alert (F35-5)

To set an audible alert when the voice privacy service is provided and cancelled:

1. Press **F**, **3** and **5** and **5**.
2. Press **Up** or **Down** to turn this feature on/off.
3. Press **F** to set.



One Minute Beep Tone (F35-6)

When this is activated, a short beep tone sounds every minute and two beep tones every five minutes.

1. Press **F**, **3** and **5** and **6**.
2. Press **Up** or **Down** to turn this feature on/off.
3. Press **F** to set.



Low Battery Alarm (F35-7)

When activated an audible alarm sounds when the battery level is low. When this occurs, recharge the battery pack or replace it with a fully charged battery pack.

1. Press **F**, **3** and **5** and **7**.
2. Press **Up** or **Down** to turn this feature on/off.
3. Press **F** to set.



Call Timers

To help manage your calls, your phone is equipped with several Call Timers.

Last Call Timer (F41-1)

1. Press **F**, **4** and **1**.
Talk time of the last call displays.
2. Press **F** to exit.

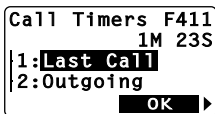

Outgoing Call Timer (F41-2)

1. Press **F**, **4** and **1** and **2**. Cumulative talk time of all outgoing calls displays. Web access calls are not included in this timer.
2. Press **F** to exit.

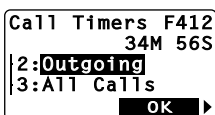

All Calls Timer (F41-3)

1. Press **F**, **4** (GHI), **1** and **3** (DEF). Cumulative talk time of all incoming and outgoing calls displays. Web access calls are not included in this timer.



```
Call Timers F413
1H 23M 45S
3: All Calls
4: Lifetime
OK
```

2. Press **F** to exit.

Note: The above three timers can be reset to zero by using **Call Timer Reset (F65-1)** on page 85.

Lifetime Timer (F41-4)

1. Press **F**, **4** (GHI), **1** and **4** (GHI). Cumulative “lifetime” talk time of all incoming and outgoing calls displays. This timer cannot be reset to zero.

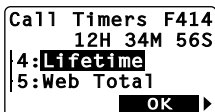

```
Call Timers F414
12H 34M 56S
4: Lifetime
5: Web Total
OK
```

2. Press **F** to exit.

Web Total Timer (F41-5)

1. Press **F**, **4** (GHI), **1** and **5** (JKL). Cumulative talk time of web access calls displays.
2. Press **F** to exit.

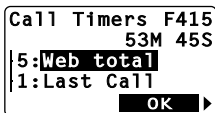

```
Call Timers F415
53M 45S
5: Web total
1: Last Call
OK
```

Note: This timer can be reset to zero by using **Call Timer Reset (F65-1)** on page 85.

Clock Indicator (F42)

To automatically display date and time:

1. Press **F**, **4** (GHI), **2** (ABC).
2. Press **^** or **v** to turn this feature on/off.
3. Press **F** to set.



```
Clock Indicator F42
On
Off
OK
```

Clock Adjustment (F43)

You can use your clock in **Auto** or **Manual** mode.

In **Auto** mode, your clock synchronizes to the base time of the CDMA system and displays the local time of the area where you are, while the  indicator is on.







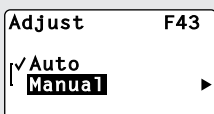





In **Manual** mode, your clock always works alone, and can be adjusted manually.

Example: To set the time to 9:15 a.m. Apr. 21, 2002 in **Manual** mode.

1. Press   .





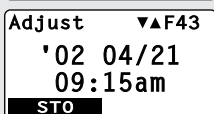

2. Scroll to "**Manual**" and press .

3. Enter the year  , month  , day  , time     and  for a.m. (or  for p.m.)



4. Press the key under **STO** to set.

Notes: 1. In step 3 above a digit can be corrected by pressing  or  after moving the cursor  or .

2. The clock works internally during power off, and will display the time in the same mode when you turn the power on.

Clock Alarm (F44)





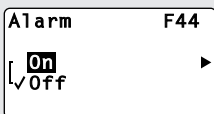

To set the alarm:

Example: To set the alarm time to 7:30 a.m.

1. Press   .



2. Scroll to "**On**" and press .

3. Enter the alarm time     and  for a.m. (or  for p.m.)

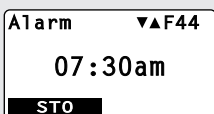

4. Press the key under **STO** to set. The  indicator will be displayed.

5. At the alarm time, the alarm will ring for one minute with animation.



6. Press any key to stop ringing.

7. The clock alarm will repeat to ring every day until you cancel the feature.

- Notes:**
1. If the alarm is set to sound during a call, the clock alarm will ring after the call.
 2. The clock alarm does not ring during power off, but this feature will be activated again when you turn the power on.
 3. The clock alarm may not ring in **Auto** mode if you miss the alarm time traveling through a different time zone.
 4. To adjust the alarm sound volume, see **Ringer Volume Control (F31)** on page 75.
 5. In place of the alarm sound, you can use **Vibrating Alert (F8)** on page 89.

Countdown Timer (F45)

Alerts you when the countdown timer expires. The timer can be set from 1 - 99 minutes.

Starting the Countdown Timer

1. Press **F4** (**4** GHI) **F5** (**5** JKL).
2. Enter the duration, 1 to 99 minutes.
3. Press **F4** to start. The  indicator will be displayed.
4. When the timer expires, the alarm will ring for one minute with animation.
5. Press any key to stop ringing.

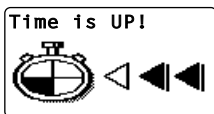
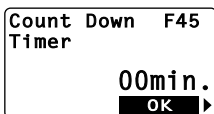

Canceling the Countdown Timer

1. Press **F4** (**4** GHI) **F5** (**5** JKL) again after the timer has started.
2. When "**Count Down Stop?**" displays on screen with the remaining minutes, scroll to "**Yes**" and press **F4** to cancel.

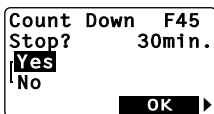







- Notes:**
1. If the timer expires during a call, the alarm will ring after the call.
 2. The countdown timer will be cancelled when you turn the power off.
 3. See **Ringer Volume Control (F31)** on page 75 to change the alarm sound volume.
 4. In place of the alarm sound, you can use **Vibrating Alert (F8)** on page 89.

System Features

A/B System Selection (F51)

Permits you to select which cellular system (A or B) your phone utilizes; remembers the last A/B setting each time it is turned on and scans radio channels based on that setting. It is strongly recommended leaving the settings as programmed.

To alter the system selection:

1. Press   . The current mode will be displayed.
2. Press  or  to change the current mode.
3. Press  to set.

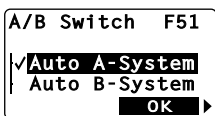

- **Auto A-System**

The phone will scan the priority systems first, and then non-priority A-systems. For more information as to how this mode works, see **Enhanced Roaming** below.

- **Auto B-System**



The phone will scan the priority systems first, and then non-priority B-systems. For more information as to how this mode works, see **Enhanced Roaming** below.

- **Home Only**

Calls can only be placed or received within your home or home affiliated areas.

Enhanced Roaming

Cellular systems are identified by a number called System Identifier or SID. Your phone is equipped with a **Preferred Roaming List (PRL)** which can be programmed by your Carrier to take advantage of the families of cellular system (SIDs) that your Carrier owns, or has special billing arrangements with, in different cities.







- In your Home System Area, both “” and “Rm” are not displayed on your phone. Outside of the Home System in Service Areas closely associated with your Carrier, the phone’s display may appear the same as when operating in the Home System.
- In areas where your Carrier has Roaming agreements, your phone will display a steady “Rm” indication. If your display indicates a flashing “Rm”, you are in a cellular system which is not associated with your Carrier (you can still make or receive calls).
- If your display indicates a flashing “”, you may have to change your A/B System Selection or NAM Selection in order to obtain service. If your display indicates “”, you are in an area where cellular service is not available.

NAM Selection (F52)

If you frequently travel, it may be beneficial to register your phone with multiple numbers for different cities. The 9155-GPX has two Number Assignment Modules (NAMs) enabling two registrations.

The NAM Selection feature enables you to change the NAM being used - do not use this feature if you do not have multiple registrations.



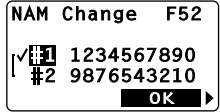

Changing NAMs:

1. Press   .
2. Press  or  to change the current NAM.
3. Press  to set.



Force Analog Call (F53)

Temporarily directs the phone to use the Analog Mode even if the Digital Mode has been previously selected.

1. Press   .
2. Press  when scanning the Analog Mode.



Notes: This feature automatically ends if:



- 1) The phone is turned off.
- 2) An outgoing call is made.
- 3) An incoming call is received.
- 4) After 10 minutes if items 1) ~ 3) did not occur.

NAM Name Display (F54-1)

A greeting or name up to 12 characters long can be programmed to display on screen when the phone is turned on or when the NAM is changed. (See **NAM Selection (F52)** on page 82.) A different name can be programmed for each NAM – the active NAM displays when the phone is turned on.

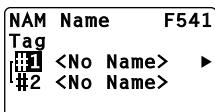
1. Press    and .



2. Press  or  to select the other NAM.

Then press  to edit.

3. Enter your message.

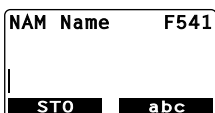







(See **Entering Letters and Symbols** on page 32.)

4. Press the key under **STO** to store the message.

Automatic NAM (F54-2)

The phone will recognize registered NAMs and automatically switch to the appropriate NAM when the area changes.

1. Press    and .

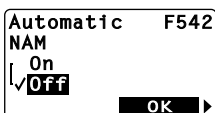

2. Press  or  to turn this feature on/off.

3. Press  to set.





Automatic Retry (F54-3)

When a call is not successfully completed this feature automatically retries the number up to seven times.

The  indicator will stay on, and the speaker will be muted. Press  to cancel the Automatic Retry.

1. Press    and .

2. Press  or  to turn this feature on/off.

3. Press  to set.



Enhanced Voice Privacy Service (F54-4) (Digital Mode Only)

If available through your service provider, this feature requests the cellular system to provide enhanced voice privacy. It can only be provided in Digital Mode.

Setting Enhanced Voice Privacy Mode:

1. Press **F**, **5** and **4** and **4**.
2. Select "Enhanced" with **↑** or **↓**, and press **F**.
3. When the phone is operating in the Enhanced Voice Privacy Mode, "VP" appears in the upper line of the display during talking.
4. Select "Standard" with **↑** or **↓**, and press **F**.



- Notes:**
1. This feature must be activated before the call is initiated.
 2. Even if the standard mode is selected, the cellular system may direct the phone to use the Enhanced Voice Privacy Mode.

Security Features

Call Restriction (F61)

This feature permits you to impose various kinds of restrictions on outgoing calls. Emergency numbers can be placed even when this feature is on.

To Set Call Restriction Mode

1. Press **F**, **6** and **1**.
2. Enter the four-digit security code and press **F**.
3. Press **↑** or **↓** to select the mode.
4. Press **F** to set.

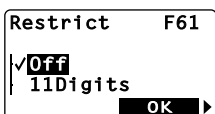

The available Restriction modes are as follows:

- **11 Digits Mode**

Only phone numbers of 11 digits or less are accepted. Operator assisted dialing is prohibited.

- **7 Digits Mode**

Only phone numbers of 7 digits or less are accepted. Operator assisted dialing is prohibited.

- **Operator Mode**

Operator assisted dialing (0 Origination Call) is prohibited.

- **Rcl 01-09 Mode**

Only outgoing calls to the numbers stored in the phonebook address range 01 – 09 can be made. If there is a need to expand this range of addresses please ask your dealer.

- **Off Mode**

No restrictions.

Changing Emergency Numbers (F62)

You can program up to three emergency numbers with a maximum of 32 digits each.

Memory Location	Preset Emergency Number
# 1	911
# 2	*911
# 3	Blank

1. Press **F** **6** **MNO** **2** **ABC**.
2. Enter the four-digit security code and press **F**.
3. Press **▲** or **▼** to select the emergency number memory location (1, 2 or 3) that you want to change or program, and press **F**.
4. Enter the new emergency number, and press **F**.

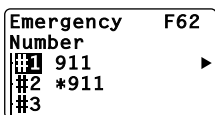

Note: The emergency number in memory location 1 will be dialed when the **One-Touch Emergency Call** feature is used.

Turning On/Off One-Touch Emergency Call Feature (F63)

1. Press **F** **6** **MNO** **3** **DEF**.
2. Enter the four-digit security code and press **F**.
3. Press **▲** or **▼** to turn this feature on/off.
4. Press **F** to set.

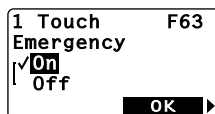

Changing Security Code (F64)

1. Press **F** **6** **MNO** **4** **GHI**.
2. Enter the four-digit security code and press **F**.
3. The current security code is displayed.
4. Enter a new four-digit security code and press **F**.

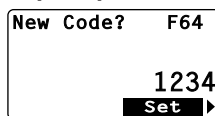

Call Timer Reset (F65-1)

To reset all the Call Timers (Last Call, Outgoing Call, All Calls, Web Total):

1. Press **F** **6** **MNO** **5** **JKL**.
2. Enter the four-digit security code and press **F**.
3. Press **1**.
4. Press **F** to reset the call timers.



Phonebook All Clear (F65-2)

To clear all phonebook locations (01-99) and the voice mail dialing memory (V+4):

1. Press **F** **6** **5**.
2. Enter the four-digit security code and press **F**.
3. Press **2**.
4. Press **F** to clear the memory.



Call History All Clear (F65-3)

To clear the outgoing and incoming call histories including Caller ID:

1. Press **F** **6** **5**.
2. Enter the four-digit security code and press **F**.
3. Press **3**.
4. Press **F** to clear the history.



Text Message & Voice Mail All Clear (F65-4)

To clear all Text Messages and Voice Mail Notification:

1. Press **F** **6** **5**.
2. Enter the four-digit security code and press **F**.
3. Press **4**.
4. Press **F** to clear the message.



Function Reset (F65-5)

To reset the User-Programmable functions:

1. Press **F** **6** **5**.
2. Enter the four-digit security code and press **F**.
3. Press **5**.
4. Press **F** to reset.



Note: See **Function Reset Status** on page 91.

Data Communications

Your phone will work as a wireless modem when connected to your PC computer or laptop with the optional data cable (MOK-9150) and when operating in digital mode. There are 3 different data settings with 3 different speeds:





- **Circuit Mode** : 14.4 kbps
- **Packet Middle** : 115.2 kbps
- **Packet High** : 144 kbps

Packet Middle and **Packet High** will work only when “1X” is displayed in the lower left-hand corner of the display. The availability of these features and the actual data speeds depend on your service provider.

Service Mode (F71)

This feature allows you to select the data service setting of your phone.

To set the Data Service Mode

1. Press   .
2. Select the desired mode by pressing .

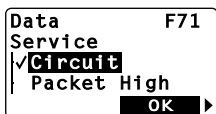

- Notes:**
1. **Data/Fax Mode (F72)** is set to “Off” automatically when you select “**Packet Middle**” or “**Packet High**” for the Data Service Mode.
 2. When your phone is in “**Packet Middle**” or “**Packet High**”, you can only use .
 3. The current setting will remain, even if the phone is powered on/off.
 4. For additional information on connecting your phone to your PC computer or laptop, please refer to the MOK-9150 owner’s manual.
 5. **Data Service Mode (F71)** must be set to “**Circuit**” to send data or fax.

Data/Fax Mode (F72)

This feature allows you to set the mode for receiving data or fax calls.

To set the Data/Fax Mode

1. Press **F▶** **7** **PQRS** **2** **ABC**.
2. Select the desired mode by pressing **F▶**.



Off: No data or fax calls can be received.

Data: Can receive data.

Fax: Can receive fax.

Data Once: Data can be received for one call.

Fax Once: Fax can be received for one call.

Notes: 1. "**Data Once**" and "**Fax Once**" will be reset to "**Off**" automatically after receiving a data or fax once or after 10 minutes.

2. Voice calls can not be received when **Data** or **Fax** modes are set.

3. **Data Service Mode (F71)** is automatically set to "**Circuit**" when the **Data/Fax Mode (F72)** is set to **Data** or **Fax**.

4. When your phone is to **Data** or **fax**, you can only use .

5. **Data/Fax mode (F72)** can not be set if TTY mode is active.

6. To send data or fax, the **Data/Fax mode (F72)** setting is not necessary. **Service Mode (F71)** must be set to "**Circuit**" to send data or fax.

TTY Mode (F73)

Your phone is able to operate with a TTY (Teletypewriter) device on 45.5 baud in both analog and digital modes. Connect a TTY device to the phone at the earphone-microphone jack, activate the TTY mode and you will place or receive calls in the same manner as ordinary calls. This feature is network dependent in the digital mode, and may not be available in all areas.

Activating TTY Mode

Press **F▶** **7** **PQRS** **3** **DEF**, scroll to "**On**" and press **F▶**. "**TTY**" will appear on the display.



Deactivating TTY Mode

Press **F▶** **7** **PQRS** **3** **DEF**, scroll to "**Off**" and press **F▶**. "**TTY**" will disappear.

- Notes:**
1. The microphone and earpiece are automatically muted during the TTY mode is active.
 2. Disconnecting a TTY device from the phone does not deactivate the TTY mode.
 3. The TTY mode will not be activated if the data/fax mode is already active.
 4. Once the TTY mode is activated, the phone will operate in the TTY mode, when the power is turned on next time.
 5. TTY devices on 50 baud are not operable with your phone.

Vibrator

Vibrating Alert (F8)

When activated, the phone vibrates to alert you of the following conditions while in standby mode. The Audible alerts will be muted.

- Incoming call received, even in **Silent** mode.
- New Text Message received, even in **Alert Off** mode.
- New Voice Mail Notification received, even in **Alert Off** mode.
- Caller ID Alert, if activated.
- Service Mode Alert, if activated.
- Clock Alarm Alert, if activated.
- Countdown Timer Alert, if activated.

Activating Vibrating Alert

Press **F▶** **8 TUV**, scroll to "On" and press **F▶**. The  indicator will be displayed.



Deactivating Vibrating Alert

Press **F▶** **8 TUV**, scroll to "Off" and press **F▶**. The  indicator will go out.



Shortcut: Press and hold ***↑** to activate or deactivate it.

Note: Be sure to turn the Vibrating Alert feature off when you use the phone in the hands-free car kit accessory.

Voice Dialing

Voice Activated Dialing (F9)

Allows you to make a call from your phonebook by just saying the name.

Press  and  to activate Voice Dialing.





Shortcut: Press and hold  to activate the same.

Note: See *Voice Activated Dialing* on page 53 for details.

Other Functions

Quick Dialing (F01)





Dials the primary numbers in phonebook addresses 02 - 09 with the touch of a single button.

1. Press   .
2. Scroll to "On" or "Off" and press .



Automatic Answering (F02)

Automatically answers incoming calls after a preset duration of ringer tones. Convenient when telephone is installed in the hands-free car kit.





1. Press   .
2. Scroll to "On" and press .
3. Enter duration (5 to 30) in seconds.
4. Press  to set.



Note: This feature will not function if the phone is in "Phone Lock", or "Keypad Lock" mode.

Redial Soft Key (F04)

Turns the "Redial" and "Refer" soft keys on or off.

1. Press   .
2. Scroll to "On" or "Off".
3. Press  to set.

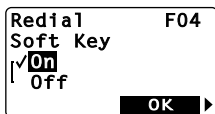

Location (F05)

Allows you to select the condition that your location is informed to the network.

Location On: The phone allows the system to measure your location at any time.

911 Only : The phone allows the system to measure your location at an emergency call.

Function Reset Status

When **Function Reset (F65-5)** is completed (see page 86), the 9155-GPX functions reset to the following:

Function Menu

Functions		Reset Status
Automatic Phone Lock (F13)		Off
Backlight Control (Standby) (F22-1)	Portable Use	10 seconds
	With Car Kit	Always On
Backlight Control (In-Use) (F22-2)		Normal
Auto Hyphenation (F23)		On
Language Selection (F24)		English
Contrast Control (F25)		Standard
Earpiece Volume Control		Level 3 (Max = 5)
Ringer Volume Control (F31)		Level 3 (Max = 5)
Ringer Type Selection (F32)		Ringer #1
Key Tone Volume Control (F33)		Level 3 (Max = 5)
Sending DTMF (F34)		On
Key Tone Length (F35-1)		Normal
Single Alert Beep Tone (F35-2)		Off
Caller ID Alert (F35-3)		On
Service Mode Alert (F35-4)		Off
Voice Privacy Alert (F35-5)		Off
One Minute Beep Tone (F35-6)		Off
Low Battery Alarm (F35-7)		On
Clock Indicator (F42)		On
Clock Adjustment (F43)		Auto
Clock Alarm (F44)		Off
Countdown Timer (F45)		0 minute
A/B System Selection (F51)		Auto-A or Auto-B
NAM Selection (F52)		NAM #1
Automatic NAM (F54-2)		Off
Automatic Retry (F54-3)		Off
Voice Privacy Service (F54-4)		Standard
Call Restriction (F61)		Off
One-Touch Emergency Call (F63)		On
Service Mode (F71)		Circuit
Data/Fax Mode (F72)		Off
TTY Mode (F73)		Off
Vibrating Alert (F8)		Off
Quick Dialing (F01)		On
Automatic Answering (F02)		Off
*Calls-in-Absence Indicator (F03)		Off
Redial Soft Key (F04)		On
Location (F05)		911 Only

* Affects hands-free operation only.

Refer to Hands-Free Car Kit (HF-9150) manual.

Function Reset Status (continued)

Messaging Feature Settings

Functions	Reset Status
Default Call Back Number	Own phone number
Default Delivery Ack	Enhanced Ack
New Message Alert	Alert On
Voice Mail Alert	Alert On
Entry Mode	T9 Mode
Save Sent Message	Auto Save
SMS Lines	4 Lines
SMS Memory Management	Auto Delete
Reply with Copy	No

See page 63 – 64.

Web Browser Settings

Functions	Reset Status
Web Lock	Off
Web Backlight	30 seconds
Web Idle Timer	30 seconds
Connect Prompt	On

See page 67.

FACEPLATE OPTIONS

Your 9155-GPX phone's faceplate is available in various color options. Always use and store your phone with the faceplate attached.

Replacing Faceplates

1. Turn the phone off and remove the battery pack. Disconnect the phone from the AC Adapter or any other device.
2. Unscrew the screw with a size S Phillips-head screwdriver. The screw stays on the phone.
3. Place a coin in the slot at the top of the phone and twist.
4. To open, pull the top of the faceplate forward.
5. Hold the phone leaning on your hand. Place the bottom of the faceplate against the bottom of the phone so that the inner tabs fit the slots. Close the faceplate and snap it shut. Make sure that all seven hooks are closed and all keys operate smoothly.
6. Tighten the screw.

Note: Prevent any dust or small things going into the phone.

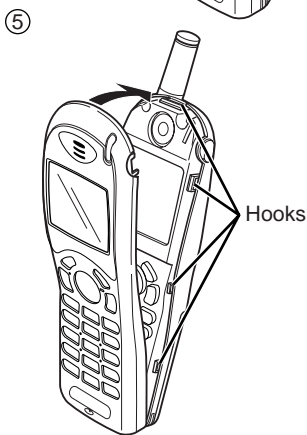
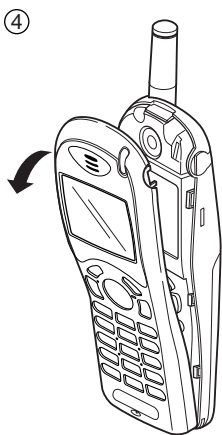
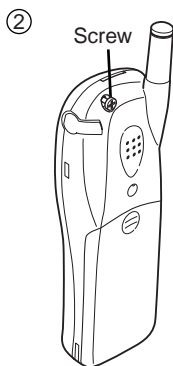



1. Do wireless phones pose a health hazard?

The available scientific evidence does not show that any health problems are associated with using wireless phones. There is no proof, however, that wireless phones are absolutely safe. Wireless phones emit low levels of radiofrequency energy (RF) in the microwave range while being used. They also emit very low levels of RF when in the stand-by mode. Whereas high levels of RF can produce health effects (by heating tissue), exposure to low level RF that does not produce heating effects causes no known adverse health effects. Many studies of low level RF exposures have not found any biological effects. Some studies have suggested that some biological effects may occur, but such findings have not been confirmed by additional research. In some cases, other researchers have had difficulty in reproducing those studies, or in determining the reasons for inconsistent results.

2. What is FDA's role concerning the safety of wireless phones?

Under the law, FDA does not review the safety of radiation-emitting consumer products such as wireless phones before they can be sold, as it does with new drugs or medical devices. However, the agency has authority to take action if wireless phones are shown to emit radiofrequency energy (RF) at a level that is hazardous to the user. In such a case, FDA could require the manufacturers of wireless phones to notify users of the health hazard and to repair, replace or recall the phones so that the hazard no longer exists.

Although the existing scientific data do not justify FDA regulatory actions, FDA has urged the wireless phone industry to take a number of steps, including the following:

- Support needed research into possible biological effects of RF of the type emitted by wireless phones;
- Design wireless phones in a way that minimizes any RF exposure to the user that is not necessary for device function; and
- Cooperate in providing users of wireless phones with the best possible information on possible effects of wireless phone use on human health.

FDA belongs to an interagency working group of the federal agencies that have responsibility for different aspects of RF safety to ensure coordinated efforts at the federal level. The following agencies belong to this working group:

- National Institute for Occupational Safety and Health
 - Environmental Protection Agency
 - Federal Communications Commission
 - Occupational Safety and Health Administration
 - National Telecommunications and Information Administration
- The National Institutes of Health participates in some inter-agency working group activities, as well.

FDA shares regulatory responsibilities for wireless phones with the Federal Communications Commission (FCC). All phones that are sold in the United States must comply with FCC safety guidelines that limit RF exposure. FCC relies on FDA and other health agencies for safety questions about wireless phones. FCC also regulates the base stations that the wireless phone networks rely upon. While these base stations operate at higher power than do the wireless phones themselves, the RF exposures that people get from these base stations are typically thousands of times lower than those they can get from wireless phones. Base stations are thus not the subject of the safety questions discussed in this document.

3. What kinds of phones are the subject of this update?

The term "wireless phone" refers here to hand-held wireless phones with built-in antennas, often called "cell," "mobile," or

“PCS” phones. These types of wireless phones can expose the user to measurable radiofrequency energy (RF) because of the short distance between the phone and the user’s head. These RF exposures are limited by Federal Communications Commission safety guidelines that were developed with the advice of FDA and other federal health and safety agencies. When the phone is located at greater distances from the user, the exposure to RF is drastically lower because a person’s RF exposure decreases rapidly with increasing distance from the source. The so-called “cordless phones,” which have a base unit connected to the telephone wiring in a house, typically operate at far lower power levels, and thus produce RF exposures far below the FCC safety limits.

4. What are the results of the research done already?

The research done thus far has produced conflicting results, and many studies have suffered from flaws in their research methods. Animal experiments investigating the effects of radiofrequency energy (RF) exposures characteristic of wireless phones have yielded conflicting results that often cannot be repeated in other laboratories. A few animal studies, however, have suggested that low levels of RF could accelerate the development of cancer in laboratory animals. However, many of the studies that showed increased tumor development used animals that had been genetically engineered or treated with cancer-causing chemicals so as to be pre-disposed to develop cancer in the absence of RF exposure. Other studies exposed the animals to RF for up to 22 hours per day. These conditions are not similar to the conditions under which people use wireless phones, so we don’t know with certainty what the results of such studies mean for human health.

Three large epidemiology studies have been published since December 2000. Between them, the studies investigated any possible association between the use of wireless phones and primary brain cancer, glioma, meningioma, or acoustic neuroma, tumors of the brain or salivary gland, leukemia, or other cancers. None of the studies demonstrated the existence of any harmful health effects from wireless phone RF exposures. However, none of the studies can answer questions about long-term exposures, since the average period of phone use in these studies was around three years.

5. What research is needed to decide whether RF exposure from wireless phones poses a health risk?

A combination of laboratory studies and epidemiological studies of people actually using wireless phones would provide some of the data that are needed. Lifetime animal exposure studies could be completed in a few years. However, very large numbers of animals would be needed to provide reliable proof of a cancer promoting effect if one exists. Epidemiological studies can provide data that is directly applicable to human populations, but 10 or more years’ follow-up may be needed to provide answers about some health effects, such as cancer. This is because the interval between the time of exposure to a cancer-causing agent and the time tumors develop - if they do - may be many, many years. The interpretation of epidemiological studies is hampered by difficulties in measuring actual RF exposure during day-to-day use of wireless phones. Many factors affect this measurement, such as the angle at which the phone is held, or which model of phone is used.

6. What is FDA doing to find out more about the possible health effects of wireless phone RF?

FDA is working with the U.S. National Toxicology Program and with groups of investigators around the world to ensure that high priority animal studies are conducted to address important questions about the effects of exposure to radiofrequency energy (RF).

FDA has been a leading participant in the World Health Organization International Electromagnetic Fields (EMF) Project

since its inception in 1996. An influential result of this work has been the development of a detailed agenda of research needs that has driven the establishment of new research programs around the world. The Project has also helped develop a series of public information documents on EMF issues.

FDA and the Cellular Telecommunications & Internet Association (CTIA) have a formal Cooperative Research and Development Agreement (CRADA) to do research on wireless phone safety. FDA provides the scientific oversight, obtaining input from experts in government, industry, and academic organizations. CTIA-funded research is conducted through contracts to independent investigators. The initial research will include both laboratory studies and studies of wireless phone users. The CRADA will also include a broad assessment of additional research needs in the context of the latest research developments around the world.

7. How can I find out how much radiofrequency energy exposure I can get by using my wireless phone?

All phones sold in the United States must comply with Federal Communications Commission (FCC) guidelines that limit radiofrequency energy (RF) exposures. FCC established these guidelines in consultation with FDA and the other federal health and safety agencies. The FCC limit for RF exposure from wireless telephones is set at a Specific Absorption Rate (SAR) of 1.6 watts per kilogram (1.6 W/kg). The FCC limit is consistent with the safety standards developed by the Institute of Electrical and Electronic Engineering (IEEE) and the National Council on Radiation Protection and Measurement. The exposure limit takes into consideration the body's ability to remove heat from the tissues that absorb energy from the wireless phone and is set well below levels known to have effects.

Manufacturers of wireless phones must report the RF exposure level for each model of phone to the FCC. The FCC website (<http://www.fcc.gov/oet/rfsafety>) gives directions for locating the FCC identification number on your phone so you can find your phone's RF exposure level in the online listing.

8. What has FDA done to measure the radiofrequency energy coming from wireless phones ?

The Institute of Electrical and Electronic Engineers (IEEE) is developing a technical standard for measuring the radiofrequency energy (RF) exposure from wireless phones and other wireless handsets with the participation and leadership of FDA scientists and engineers. The standard, "Recommended Practice for Determining the Spatial-Peak Specific Absorption Rate (SAR) in the Human Body Due to Wireless Communications Devices: Experimental Techniques," sets forth the first consistent test methodology for measuring the rate at which RF is deposited in the heads of wireless phone users. The test method uses a tissue-simulating model of the human head. Standardized SAR test methodology is expected to greatly improve the consistency of measurements made at different laboratories on the same phone. SAR is the measurement of the amount of energy absorbed in tissue, either by the whole body or a small part of the body. It is measured in watts/kg (or milliwatts/g) of matter. This measurement is used to determine whether a wireless phone complies with safety guidelines.

9. What steps can I take to reduce my exposure to radiofrequency energy from my wireless phone?

If there is a risk from these products—and at this point we do not know that there is—it is probably very small. But if you are concerned about avoiding even potential risks, you can take a few simple steps to minimize your exposure to radiofrequency energy (RF). Since time is a key factor in how much exposure a person receives, reducing the amount of time spent using a wireless phone will reduce RF exposure.

- If you must conduct extended conversations by wireless phone every day, you could place more distance between your body and the source of the RF, since the exposure level drops off dramatically with distance. For example, you could use a headset and carry the wireless phone away from your body or use a wireless phone connected to a remote antenna.

Again, the scientific data do not demonstrate that wireless phones are harmful. But if you are concerned about the RF exposure from these products, you can use measures like those described above to reduce your RF exposure from wireless phone use.

10. What about children using wireless phones?

The scientific evidence does not show a danger to users of wireless phones, including children and teenagers. If you want to take steps to lower exposure to radiofrequency energy (RF), the measures described above would apply to children and teenagers using wireless phones. Reducing the time of wireless phone use and increasing the distance between the user and the RF source will reduce RF exposure.

Some groups sponsored by other national governments have advised that children be discouraged from using wireless phones at all. For example, the government in the United Kingdom distributed leaflets containing such a recommendation in December 2000. They noted that no evidence exists that using a wireless phone causes brain tumors or other ill effects. Their recommendation to limit wireless phone use by children was strictly precautionary; it was not based on scientific evidence that any health hazard exists.

11. What about wireless phone interference with medical equipment?

Radiofrequency energy (RF) from wireless phones can interact with some electronic devices. For this reason, FDA helped develop a detailed test method to measure electromagnetic interference (EMI) of implanted cardiac pacemakers and defibrillators from wireless telephones. This test method is now part of a standard sponsored by the Association for the Advancement of Medical Instrumentation (AAMI). The final draft, a joint effort by FDA, medical device manufacturers, and many other groups, was completed in late 2000. This standard will allow manufacturers to ensure that cardiac pacemakers and defibrillators are safe from wireless phone EMI.

FDA has tested hearing aids for interference from handheld wireless phones and helped develop a voluntary standard sponsored by the Institute of Electrical and Electronic Engineers (IEEE). This standard specifies test methods and performance requirements for hearing aids and wireless phones so that no interference occurs when a person uses a "compatible" phone and a "compatible" hearing aid at the same time. This standard was approved by the IEEE in 2000.

FDA continues to monitor the use of wireless phones for possible interactions with other medical devices. Should harmful interference be found to occur, FDA will conduct testing to assess the interference and work to resolve the problem.

12. Where can I find additional information?

For additional information, please refer to the following resources:

- FDA web page on wireless phones (<http://www.fda.gov/cdrh/phones/index.html>)
- Federal Communications Commission (FCC) RF Safety Program (<http://www.fcc.gov/oet/rfsafety>)
- International Commission on Non-Ionizing Radiation Protection (<http://www.icnirp.de>)
- World Health Organization (WHO) International EMF Project (<http://www.who.int/emf>)
- National Radiological Protection Board (UK) (<http://www.nrpb.org.uk/>)

EMERGENCY CALLS

Never rely solely upon your wireless phone for essential communications (e.g. medical emergencies), if it can be avoided, since a wireless phone requires a complex combination of radio signals, relay stations and landline networks for its operation. Consequently, emergency calls may not always be possible under all conditions on all wireless phone systems.

Your wireless phone, however, may sometimes be the only available means of communication at the scene of an accident. When making an emergency call, always give the recipient all necessary information as accurately as possible. Never terminate an emergency call until you have received clearance to do so.

FCC Enhanced 911 (E911) Rules Background

The Federal Communications Commission (FCC) requires wireless carriers to transmit specific latitude and longitude location (Automatic Location Identification = ALI) information as well as “911” calls to Public Safety Answering Points (PSAPs) to identify the location of the caller in case of emergency.

Accuracy requirement for ALI information by FCC E911 rules is within 50 meters for 67 percent of calls and within 150 meters for 95 percent of calls (FCC’s ALI Requirements).

9155-GPX’s ALI Capability

The Audiovox 9155-GPX is an ALI-capable phone equipped with the GPS (Global Positioning System: Satellite assisted location information system) receiver supporting GPS based ALI-capable network to comply with the FCC’s ALI requirements.

The network compliance with the above FCC requirements is dependent on: (a) the use of digital technology by the wireless network; (b) GPS satellite signals being able to reach the handset (such transmissions do not always work indoors, for example) ; and (c) handset signals reaching wireless “base stations” (atmospheric and environmental conditions may cause variations in handset receiving signal strength).

Also the transmission of the ALI information is subject, in part, to system constraints within the wireless network to which the E911 signal is transmitted and over which Audiovox has no control.

Finally, customers are advised that the 9155-GPX’s ALI capability is to be used for E911 purposes only.

OPERATING PROCEDURES

Never violate any of the following Rules and Regulations of the FCC when using your Cellular Phone. Such violations are punishable by fine, imprisonment or both.

- Never use obscene, indecent, or profane language.
- Never use your Cellular Phone to send false distress calls.
- Never wiretap or otherwise intercept a phone call, unless you have first obtained the consent of the parties participating in the call.
- Never make any anonymous calls to annoy, harass, or molest other people.
- Never charge another account without authorization, to avoid payment for service.
- Never willfully or maliciously interfere with any other radio communications.
- Never refuse to yield the line when informed that it is needed for an Emergency Call. Also, never take over a line by stating falsely that it is needed for an emergency.

The 9155-GPX is using one or more of the following US patents licensed by QUALCOMM Incorporated:

4,901,307	5,544,196
5,490,165	5,267,262
5,056,109	5,568,483
5,504,773	5,337,338
5,101,501	5,600,754
5,506,865	5,414,796
5,109,390	5,657,420
5,511,073	5,416,797
5,228,054	5,659,569
5,535,239	5,710,784
5,267,261	5,778,338

T9® Text Input is covered by U.S. Pat. 5,818,437, U.S. Pat. 5,953,541, U.S. Pat. 6,011,554 and other patents pending.

INDEX

- A**
Alpha Mode 32
Any Key Answering 27
Automatic Answering 90
- B**
Backlight Control
In-Use 73
Standby 73
Battery
Alarm 77
Attach/Detach 19
Recharge 20
- C**
Call
Place 25
Receive 27
Terminate 25
Call History 54
All Clear 86
Call Restriction 84
Calls-in-Absence Indicator ... 28
Call Timers 77
Reset 85
Call Waiting 29
Caller ID 28
Alert 76
Clock Alarm 30, 79
Clock Indicator 30, 78
Contrast 74
Countdown Timer 30, 80
- D**
Data/Fax 88
Distinctive Ringing 28
DTMF 75
- E**
E-mail 39, 45, 59, 66
Emergency Call 26
One-Touch 27, 85
Emergency Number
Change 85
Enhanced Roaming 81
- F**
Force Analog Call 82
Function Menu
Access 69
Tree 70
Function Reset 86
- H**
Hyphenation
Auto 36, 74
Manual 36
- K**
Keypad Lock 71
- L**
Language 30, 74
Link Dialing 50
- M**
Mute 29
- N**
NAM
Automatic 83
Selection 82
Name Display 83
- O**
Own Telephone
Number 73
- P**
Packet Mode 87
Phone Lock 72
Automatic 72
Unlock 72
Phonebook
All Clear 86
Phonebook Edit
Change Priority 48
Erase 48
Modify 46
Move 47
Phonebook Entry
Automatic Storing 35
Dual Numbers 37
Name 38
Number 35
Overwrite 41
Ringer Type 40
Phonebook Recall
Address Mode 43
Key Word Search Mode ... 44
Sort Scroll Mode 43
Prepending Dialing 45
PRL 74, 81
- Q**
Quick Dialing 26, 90
- R**
Recall Menu 42
Retry 83
Ringer Type 75
Ringing Tone 28
- S**
Scratch Pad 29, 56
Secret Memory 49
Security Code 71, 85
Short Message Service 57
SID 74, 81
Speakerphone 29
Speed Dialing 26
System Selection 81
- T**
Talk Timer 29
Text Messages 57
Alert 63
All Clear 86
Receive 58
Send 59
Touch Tone™
from Display 31
from Memory 31
TTY 88
- U**
Unlock Code 71, 72
- V**
Vibrating Alert 30, 89
Voice Activated Dialing 52
Voice Mail
Alert 63
All Clear 86
Dialing (VY/4) 62
Notification 61
Voice Privacy 83
Alert 77
Volume
Earpiece 28
Key Tone 75
Ringer 75
- W**
Web Browsing 65

12 MONTH LIMITED WARRANTY

Audiovox Communications Corp. (the Company) warrants to the original retail purchaser of this Audiovox handheld portable cellular telephone, that should this product or any part thereof during normal consumer usage and conditions, be proven defective in material or workmanship that results in product failure within the first twelve (12) month period from the date of purchase, such defect(s) will be repaired or replaced (with new or rebuilt parts) at the Company's option, without charge for parts or labor directly related to the defect(s).

The antenna, keypad, display, rechargeable battery and battery charger, if included, are similarly warranted for twelve (12) months from date of purchase.

This Warranty extends only to consumers who purchase the product in the United States or Canada and it is not transferable or assignable.

This Warranty does not apply to:

- (a) Product subjected to abnormal use or conditions, accident, mishandling, neglect, unauthorized alteration, misuse, improper installation or repair or improper storage;
- (b) Product whose mechanical serial number or electronic serial number has been removed, altered or defaced.
- (c) Damage from exposure to moisture, humidity, excessive temperatures or extreme environmental conditions;
- (d) Damage resulting from connection to, or use of any accessory or other product not approved or authorized by the Company;
- (e) Defects in appearance, cosmetic, decorative or structural items such as framing and non-operative parts;
- (f) Product damaged from external causes such as fire, flooding, dirt, sand, weather conditions, battery leakage, blown fuse, theft or improper usage of any electrical source.

The Company disclaims liability for removal or re-installation of the product, for geographic coverage, for inadequate signal reception by the antenna or for communications range or operation of the cellular system as a whole.

To obtain repairs or replacement within the terms of this Warranty, the product should be delivered with proof of Warranty coverage (e.g. dated bill of sale), the consumer's return address, daytime phone number and/or fax number and complete description of the problem, transportation prepaid,

to the Company at the address shown below or to the place of purchase for repair or replacement processing. In addition, for reference to an authorized Warranty station in your area, you may telephone in the United States (800) 229-1235, and in Canada (800) 465-9672 (in Ontario call 905-712-9299).

THE EXTENT OF THE COMPANY'S LIABILITY UNDER THIS WARRANTY IS LIMITED TO THE REPAIR OR REPLACEMENT PROVIDED ABOVE AND, IN NO EVENT, SHALL THE COMPANY'S LIABILITY EXCEED THE PURCHASE PRICE PAID BY PURCHASER FOR THE PRODUCT.

ANY IMPLIED WARRANTIES, INCLUDING ANY IMPLIED WARRANTY OF MERCHANTABILITY OR FITNESS FOR A PARTICULAR PURPOSE SHALL BE LIMITED TO THE DURATION OF THIS WRITTEN WARRANTY. ANY ACTION FOR BREACH OF ANY WARRANTY MUST BE BROUGHT WITHIN A PERIOD OF 18 MONTHS FROM DATE OF ORIGINAL PURCHASE. IN NO CASE SHALL THE COMPANY BE LIABLE FOR ANY SPECIAL CONSEQUENTIAL OR INCIDENTAL DAMAGES FOR BREACH OF THIS OR ANY OTHER WARRANTY, EXPRESS OR IMPLIED, WHATSOEVER. THE COMPANY SHALL NOT BE LIABLE FOR THE DELAY IN RENDERING SERVICE UNDER THIS WARRANTY OR LOSS OF USE DURING THE TIME THE PRODUCT IS BEING REPAIRED OR REPLACED.

No person or representative is authorized to assume for the Company any liability other than expressed herein in connection with the sale of this product.











Some states or provinces do not allow limitations on how long an implied warranty lasts or the exclusion or limitation of incidental or consequential damage so the above limitation or exclusions may not apply to you. This Warranty gives you specific legal rights, and you may also have other rights which vary from state to state or province to province.

IN USA: AUDIOVOX COMMUNICATIONS CORP.
555 Wireless Blvd.
Hauppauge, NY 11788
(800) 229-1235











IN CANADA: AUDIOVOX CANADA LTD.
5155 Spectrum Way, Unit #5
Mississauga, Ontario L4W 5A1
(800) 465-9672

QUICK REFERENCE

Basic Operation

Turn On/Off	Press and hold 
Place a Call	Phone Number, 
Terminate a Call	
Receive a Call	Any Key (except  and )
Clear Last Digit	
Clear All Digits	Press and hold 
Ear/SPK Volume	 or  during a call
Speakerphone (Two-Way)	 during a call

Convenience Features











Phonebook Dialing	 , Phonebook Address, 
Speed Dialing	Phonebook Address, 
Last Number Redial	  
Dial Last Incoming Call	  
Vibrating Alert	Press and hold 
Voice Activated Dialing	Press and hold 

Messaging Features











Received Text Messages	Press and hold 
Number of Voice Mail	 , "Voice mail", 
Voice Mail Dialing	

QUICK REFERENCE





Basic Operation

Turn On/Off	Press and hold 
Place a Call	Phone Number, 
Terminate a Call	
Receive a Call	Any Key (except  and )
Clear Last Digit	
Clear All Digits	Press and hold 
Ear/SPK Volume	 or  during a call
Speakerphone (Two-Way)	 during a call

Convenience Features

Phonebook Dialing	 , Phonebook Address, 
Speed Dialing	Phonebook Address, 
Last Number Redial	  
Dial Last Incoming Call	  
Vibrating Alert	Press and hold 
Voice Activated Dialing	Press and hold 

Messaging Features

Received Text Messages	Press and hold 
Number of Voice Mail	 , "Voice mail", 
Voice Mail Dialing	

Functions

Mute/Unmute	F▶ F▶
Keypad Lock	F▶ 1 1
Lock the Phone	F▶ 1 2 ABC
Automatic Lock	F▶ 1 3 DEF
Display Own Phone Number & SID	F▶ 2 ABC 1
Backlight Control	F▶ 2 ABC 2 ABC
Language Selection	F▶ 2 ABC 4 GHI
Last Call Time Display	F▶ 4 GHI 1
Outgoing Call Time Display	F▶ 4 GHI 1 2 ABC
All Calls Time Display	F▶ 4 GHI 1 3 DEF
A/B System Selection	F▶ 5 JKL 1
Service Mode	F▶ 7 PQRS 1
Data/Fax Mode	F▶ 7 PQRS 2 ABC
TTY Mode	F▶ 7 PQRS 3 DEF
Vibrating Alert	F▶ 8 TUV
Automatic Answering	F▶ 0 ↻ 2 ABC

Functions

Mute/Unmute	F▶ F▶
Keypad Lock	F▶ 1 1
Lock the Phone	F▶ 1 2 ABC
Automatic Lock	F▶ 1 3 DEF
Display Own Phone Number & SID	F▶ 2 ABC 1
Backlight Control	F▶ 2 ABC 2 ABC
Language Selection	F▶ 2 ABC 4 GHI
Last Call Time Display	F▶ 4 GHI 1
Outgoing Call Time Display	F▶ 4 GHI 1 2 ABC
All Calls Time Display	F▶ 4 GHI 1 3 DEF
A/B System Selection	F▶ 5 JKL 1
Service Mode	F▶ 7 PQRS 1
Data/Fax Mode	F▶ 7 PQRS 2 ABC
TTY Mode	F▶ 7 PQRS 3 DEF
Vibrating Alert	F▶ 8 TUV
Automatic Answering	F▶ 0 ↻ 2 ABC

9155-GPX

TRI-MODE CDMA DIGITAL 1x WIRELESS HANDSET

ACCESSORIES



BC-9100
Belt Clip



BTR-9100
Lithium Ion
Battery Pack



CLC-9100
Cigarette Lighter
Charger



CNR-9100
AC Adapter



TRC-9100
Travel Charger



MOK-9150
Mobile Office Kit



DTC-9100
Desktop
Charger



DTH-9100
Desktop
Holder



EM-425
Earbud



CHF-9100
Cigarette Lighter
Hands-Free Kit



HS-911
Earclip with
Boom Mic



JEARBOOM, JEARWRAP
JEARSET
Hands-Free Headset



HF-9150
Hands-Free Car Kit



PCP-9155
User Changeable
Faceplates



LB-9100
Leather
Carrying Case

PROTECT YOUR WARRANTY

Carefully read the Limited Warranty for your cellular phone, giving special consideration to paragraph seven.

“Warranty does not apply to... any damage that has resulted from the connection to, or use of, any accessories not expressly approved by Audiovox”.

Some companies are marketing look-alike accessories that are not compatible for use with your Audiovox product and may damage the unit or cause it to malfunction.

If service is required on your unit, and it is determined that a non-Audiovox accessory has created the problem, your Warranty will not apply.

In addition, if the unit has sustained irreversible damage by reason of a non-compatible accessory, the Warranty will also be voided.

To protect your Warranty, always use compatible accessories that are approved by Audiovox and that cannot damage or interfere with the proper functioning of your cellular phone.



AUDIOVOX COMMUNICATIONS CORP.

555 Wireless Blvd., Hauppauge, New York 11788, 800-229-1235
16808 Marquardt Avenue, Cerritos, California 90701, 562-802-5100

Audiovox Canada
5155 Spectrum Way, Unit #5, Mississauga, Ontario
Canada L4W 5A1, 800-465-9672

Audiovox Pacific Pty Ltd
110 Rocky Point Road, Kogarah, NSW 2217, Australia,
02-9587-0000

Audiovox New Zealand Pty Ltd
Unit B, 6 Henderson Place, Auckland, 6496345720

Audiovox Singapore Pte Ltd
268 Orchard Road, #07-07, Singapore, 238856, 65-733-5902

<http://www.audiovox.com>

